



Strange

HIGH PERFORMANCE COMPONENTS

MOPAR

GET NOTICED. GET CONNECTED. GET STRANGE.



Strange

GOT STRANGE? Well now you can look Strange with Strange apparel. Visit us at Strangeeng.net and gear up with one of our latest designs to show the world just how Strange you are.



Our founder, Bob Stange, was born and raised in Chicago and began his career almost 60 years ago. He got this start working in machine shops during the day and making suspension parts for him and his friends' drag cars in his mom's garage at night.

We weren't always Strange. A printing error in the 60's resulted in the long standing respectable name that we proudly bear today when it changed Stange Engineering to Strange Engineering. Since then, we have grown into an industry leading manufacturing company housed on a 120,000 square foot site and we continue to fuel the passion for the sport of Drag Racing!

DON'T JUST RACE...
RaceStrange



Follow us on social media and hang on while we guide you through the world of Strange Racing and Strange Events.



Like racing? How about racing for up to \$20k?
Come see us at Gearheadracingseries.com

CONTENTS

Axle Packages/Components

Alloy Axles & Packages.....	8-17
Axle Bearings.....	29
Axle Order Form Info.....	6-7
Pro Race Axles & Packages....	16-25
Retainer Plates.....	19
Wheel Studs.....	17-18

Bolt-in Strange Housings

Housing Ends.....	30-31
Strange S60.....	28-29

Brake Kits/Components

Brakes Technical.....	38-39
Brake Line Kits & Fittings.....	50-52
Brake Pads (Steel Rotors).....	49
Calipers & Caliper Kits.....	40, 47, 49
Caliper Rebuild Kits.....	49
Drum Brake Kits.....	53
Master Cylinders.....	50
Pressure Gauge.....	51

Brake Kits/Components

Proportioning Valve.....	50
Pro Series II Stainless.....	43,46
Replacement Steel Rotors.....	48
Residual Valves.....	50
Steel Drag Kits (Rear).....	42-43, 46
Steel Drag Kits (Front).....	44-45
Wilwood Rear Brake Kits.....	53

Differentials.....

24-25

Driveline Components

Driveshaft Components.....	58
Magnetic Sensor Collars.....	60
Pinion Yokes.....	60
Transmission Yokes.....	58-59
Driveshafts.....	56-57
U-Joints & U-Bolts.....	58

Floater Kits/Components

Drag Race & Pro Touring.....	36-37
------------------------------	-------

Gear Sets/Installation Kits

Mopar.....	22-23
Gear Ratio Calculator.....	21
Lighten Gear Service.....	20
Micro Blue Service.....	21

S60/ Dana 60/ Mopar 8 3/4"

Alloy Axle Packages.....	9
Alloy Axle & Spool Packages...	10
Bare S60 Housings.....	28-29
Complete S60 Housings.....	34-35
Differentials & Spools	24-25
Gear Sets & Installation Kits...	22-23
Pinion Yokes.....	62
Pro Race Axle Packages.....	13-14
Pro Race Axle & Spool Pkgs...	15-16
Rear Covers & Main Caps.....	26-27
Shocks (Bolt-in).....	54-55

Labor Rates.....

62-63

Rear Covers & Main Caps.....

26-27

Terms & Conditions.....

6



TERMS & CONDITIONS

TERMS

Orders may be shipped Certified Check, VISA, MASTER CARD, AMERICAN EXPRESS, OR DISCOVER CARD. Minimum order is \$10.00.

CLAIMS

Claims for damages in shipping, open or sealed, are to be made to freight forwarder. Claims for shortages must be made directly to Strange Engineering within 5 days of receipt.

RETURNS

Special order parts are non-returnable. No returns will be accepted without prior authorization. Please contact a Strange Engineering associate for a Returned Merchandise Authorization number. Returns must be in new condition. Any part that has been installed or used will not be credited. All returns are subject to a 20% handling charge (minimum \$10) and return freight must be prepaid.

PRICING

Prices are subject to change without notice.

DISCLAIMER OF WARRANTY

Strange Engineering reserves the right to make changes in design and to add to or improve on its product without incurring any obligation to install the same on products previously manufactured.

Purchasers using Strange Engineering racing components and equipment as well as any and all inventory services, acknowledge that due to the differing conditions and circumstances under which all equipment and parts are installed and used, purchasers are not relying on Strange Engineering's skills or judgments to select or furnish the proper part or equipment. Purchasers expressly affirm they are relying upon their own skill or judgment to select and purchase suitable goods.

Strange Engineering makes no warranties whatsoever, expressed or implied, oral or written, to purchasers. There is no warranty of merchantability made to purchasers. Strange Engineering further excludes any implied warranty of fitness with respect to racing, equipment, any and all inventory and service.

AXLE REPLACEMENT GUARANTEE

Strange Alloy (induction hardened) 33 and 35 spline axles and Strange Pro Race Axles (thru-hardened) with 33, 35 (excluding gun-drilled) and 40-splines are guaranteed against spline breakage to the original owner for a period of five years. This replacement policy shall not apply to any product which has been repaired or altered in anyway so as in our judgment affects its performance; nor which has been subject to misuse, abuse, negligence or any other occurrence beyond the control of Strange Engineering. The replacement policy is effective from the invoice shipping date. In no way does Strange Engineering accept responsibility or liability beyond repair or replacement.

SPOOL REPLACEMENT GUARANTEE

Strange Pro Race steel spools carry a lifetime replacement policy against breakage to the original owner with proof of purchase. This replacement policy is only valid when the spool is used with Strange or unmodified OEM axles- this is due to irregularly cut and non-involute splines which occur in re-spline and cut spline axles which provide poor spline contact area. This replacement policy shall not apply to any product which has been repaired or altered in anyway so as in our judgment affects its performance; nor which has been subject to misuse, abuse, negligence or any other occurrence beyond the control of Strange Engineering. The replacement policy is not warrantied against excessive run-out due to ring and/or pinion breakage. The replacement policy is effective from the invoice shipping date. In no way does Strange Engineering accept responsibility or liability beyond repair or replacement.

BEING STRANGE

Strange Engineering has over 50 years of manufacturing experience in the performance industry. Strange has grown from creating products inside a two car garage in the late 50's to an industry leading manufacturing company housed on a 120,000 square foot site.

The family owned business is still based on principles the company was founded on- quality product, quality service and a true enthusiasm for the performance industry.



STRANGE PRO RACE VS ALLOY AXLES

The best tool for the job is the right tool for the job. Strange Engineering prides itself on supplying the best possible product for your particular application. Many years of experience have created different axle designs based on their intended use. After considering the loads and forces that the axle will endure, the right material is chosen along with the proper heat treatment to optimize its characteristics. Since this can not be accomplished by only one type of axle, it has led to the development of both Pro Race Axles and Alloy Axles. Quality is ensured as all Strange axles are proudly made in the USA by Strange Engineering.

PRO RACE - THRU-HARDENED

MATERIAL

Hy-Tuf ultra strength forged alloy steel

HEAT TREATMENT

Thru-hardened @ Rc 45-46
Full depth of shaft

APPLICATION

Competitive Drag Racing

ORIGIN

Hy-Tuf was originated in the class of Ultra-Strength alloys, which was developed for highly stressed landing gear in military aircrafts. The material is a low carbon, high manganese, high-nickel and high molybdenum steel.

PROPERTIES

Each Pro Race Axle is heat treated in a vertical furnace to a hardness of Rc 45-46. The axle is the same hardness from the center of the shaft to the surface (thru-hardened).

The combination of Hy-Tuf and thru-hardened heat treatment provides an axle that achieves superior torsional strength and ductility. In addition, thru-hardened Hy-Tuf is ideal for weight saving gun-drilled and ultra light axles. More drag racers depend on Strange Hy-Tuf Pro Race Axles than all other brands combined.

Pro Race (thru-hardened) and Alloy (induction hardened) axles are all NHRA & IHRA accepted; however, Strange Engineering maintains the highest standards in the industry for safety and performance. Therefore, we strongly recommend our thru-hardened Pro Race shafts for all competitive drag racing applications.



ALLOY - INDUCTION HARDENED

MATERIAL

Modified 1550 premium forged alloy steel

HEAT TREATMENT

Induction Hardened @ Rc 58-62
Hardness decreases from surface to the axle core

APPLICATION

High performance Street and Track

ORIGIN

1550 proved to be an excellent material for street applications, but required different properties to be suitable for track use as well. Various modifications were tested until the proper combination resulted in the material use today.

PROPERTIES

Induction hardening is a process in which an axle is pulled through an electrical coil. The electric coil heats and quenches the shaft. This type of heat treatment is ideal for hardening the case of the shaft while the axle shaft core and flange remain soft, allowing for an extremely ductile axle.

The combination of a premium alloy steel and induction hardening creates an axle which is able to survive the bending loads that are inherent with street use.

Strange Alloy Axles are offered in 28, 30, 31, 33 and 35 spline applications. Shafts up to 31 spline are ideal for street applications with the use of posi-units, Detroit Lockers, and helical gear differentials. The 33 and 35-spline axles are able to withstand even higher torque and bending loads. 35-spline alloy axles are well suited for street and track applications. They can be used with Detroit Lockers, Helical gear differentials, and spools. Spools are for racing applications only and should never be used on the street.

While Strange Alloy Axles are NHRA and IHRA accepted, the Pro Race Axles offer superior torsional and axle flange strength for the ultimate in Drag Race Only applications.

AXLE ORDERING INFORMATION

Strange axles are manufactured to meet each customer's needs. In order for us to produce an optimal axle fit, we have provided the following text and illustrations to assist you with supplying the necessary axle information. Please do not hesitate to call us if you have any questions.

Complete the information for Rear End Housing form if you cannot determine dimension C. The C dimension of an existing axle may be affected by changes to the housing ends, carrier, and brakes. When brakes are changed, so are many of the axle dimensions. Any additional information provided will help ensure a proper fit. Give all the necessary information for existing axles provided everything will remain the same. The facing page has a housing end identification chart as well as common OEM and aftermarket dimensions that can be useful to verify the measurements you are supplying.

INFORMATION FOR AXLE ORDER FORM

- (1) Application - Street, Track, Street and Strip, or Drag Race Only
- (2) Carrier - Differential or spool, and manufacturer
The original C dimensions may change if the carrier is replaced
- (3) Number of axle splines
- (4) Bolt Circle - See chart
- (5) Tapped for screw in studs (1/2-20 or 5/8-18)
Only Alloy Axles can be drilled for knurled studs - Specify knurl size
- (6) Housing end type - Shape may vary- Please verify dimensions
- (7) Type of brakes and manufacturer- Drum, factory disc, or aftermarket
Aftermarket brake companies should supply F dimension
- (8) D dimension - Axle flange OD is 6.245" unless specified otherwise
- (9) Driver side and passenger side C dimension - See axle diagram
- (10) A dimension - Brake register - See axle diagram
- (11) B dimension - Bearing seat - See axle diagram
- (12) H dimension - Bearing area diameter - See axle diagram
- (13) F dimension - Brake offset - See housing diagram
B and F are not the same dimension - See Notes
- (14) Passenger side housing end to center of pinion - Dimension L
- (15) Driver side housing end to center of pinion - Dimension O
- (16) Housing end to housing end - Dimensions L + O
- (17) Passenger side axle flange to center of pinion - Dimension M
- (18) Driver side axle flange to center of pinion - Dimension J
- (19) Axle flange to axle flange - Dimensions M + J
Do not add thickness of brake hat or drum

COMMON OEM DIMENSIONS

Chrysler / Dana / Mopar

- A dimension - 2.300" or 2.820"
B dimension - 2.200", 2.312", or 2.562"
F dimension - 2.238, 2.350", or 2.600"
H dimension - 1.563"
Bolt circle - 5 on 4 1/2"

Ford

- A dimension - 2.430", 2.530", 2.750", 2.780",
2.796", 2.875, or 3.060"
B dimension - 1.875", 2.062", 2.125", 2.250",
2.375" or 2.437"
F dimension - 2.145", 2.332", 2.500", or 2.625"
H dimension - 1.379", 1.400", 1.532", 1.563",
1.626" or 1.773"
Bolt circle - 4 on 4 1/4", 5 on 4 1/2', 5 on 5 1/2"

General Motors

- A dimension - 2.780", 2.812", or 3.060"
B dimension - 2.562", C-clip style axle (none)
F dimension - 2.832"
H dimension - 1.379", 1.400", 1.532", 1.563"
1.626, or 1.773"
Bolt circle - 5 on 4 3/4", 5 on 5", 5 on 5 1/2"

Notes:

- Axle flange to axle flange is measured from the outside face of the axle flanges without any brakes installed.
- If you have listed only housing end to housing end or axle flange to axle flange, please specify pinion offset.
- The B dimension is from the outside face of axle flange to the bearing shoulder machined onto the axle.
- The F dimension is measured from outside face of bare axle flange to the outside face of the housing end.
Chrysler / Dana / Mopar housing ends do not have an internal step to stop the axle bearing.
Therefore, the F dimension is obtained with the backing plate and gasket installed or their combined thickness accounted for.
- When upgrading to 35 spline axles in a Ford 9", an aftermarket 3.250" bore case is required.

AXLE FORM

X	Bolt Circle
2.645"	4 1/2"
2.792"	4 3/4"
2.939"	5"
3.233"	5 1/2"

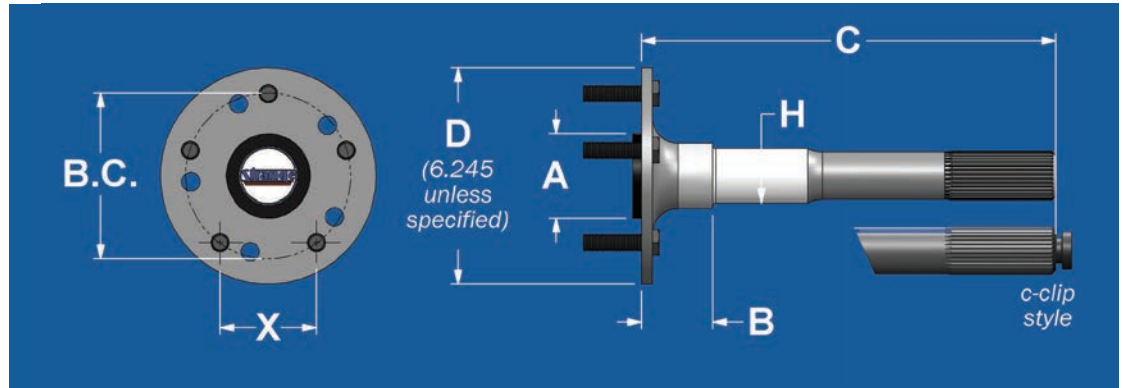

HOUSING FORM

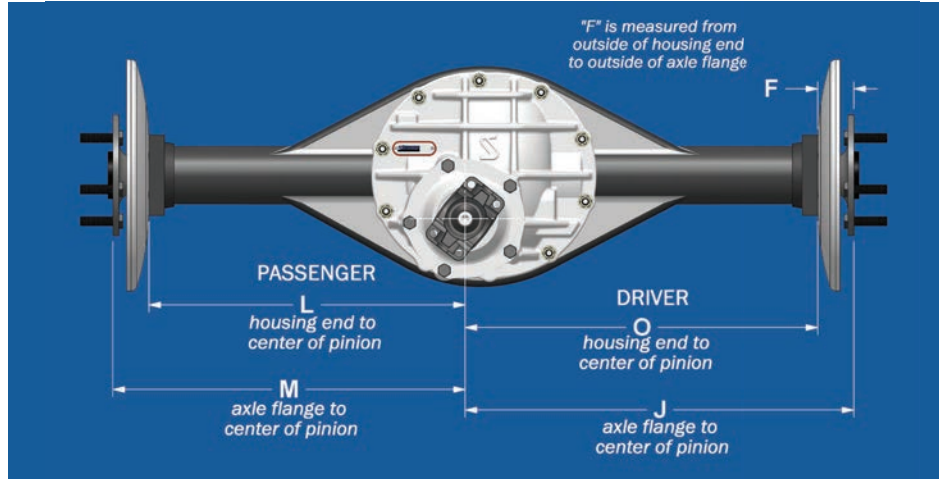

HOUSING END IDENTIFICATION CHART

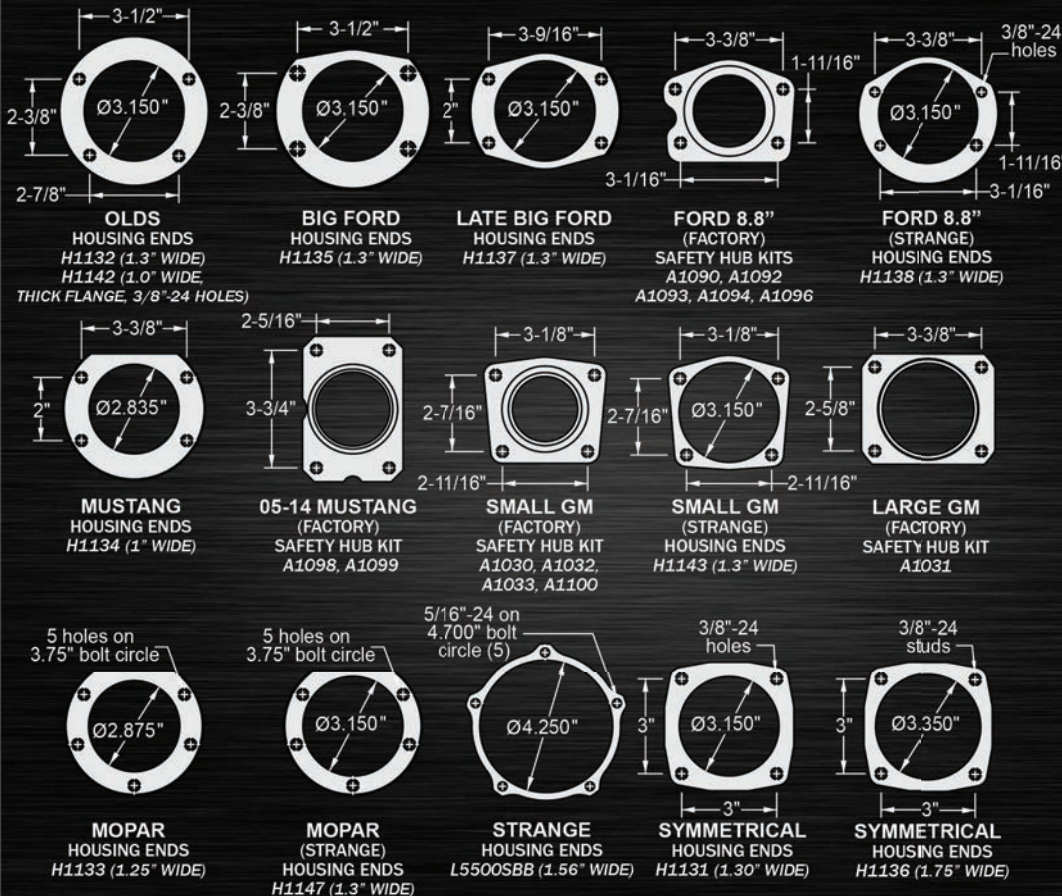

Housing End Chart

Notes:

(1) **FACTORY** indicates OEM style housing ends that Strange does not manufacture and are listed for identification purposes; however, we do offer c-clip eliminator kits. C-clip eliminator kits may require new axles- call for your application.

(2) Big Ford or late big Ford OEM housing ends may vary in shape and housing end stud hole size.

AXLES

ALLOY AXLE PACKAGES

- **2 day turnaround**
 - **Designed for your custom street and hi-performance vehicle**
 - **CNC machined from premium forged alloy steel**
 - **Induction hardened to resist bending loads and provide a more flexible axle**
 - **Radius rings to minimize stress concentrations**
 - **Axles for Dana 60, Ford 8.8", 9", GM 12 bolt, 10 bolt, 57-64 Olds, Mopar 8 3/4"**
 - **28, 30, 31, 33, & 35 spline**
 - **Alloy 35 spline axles designed for your street/strip requirements**

Strange Alloy Axles are designed to meet the demanding bending loads of street use. Manufactured from premium alloy steel forgings, each alloy axle is induction hardened to its optimal hardness with Strange designed tooling. Alloy axle splines are hobbled to the proper involute spline before heat treatment. The axles are made with a large 1.563" diameter axle bearing area and the shoulder accepts a radius ring that minimizes stress concentrations. A billet aluminum brake register is provided to properly locate the center of your disc or drum brake system.

Alloy axles are offered in 28, 30, 31, 33 and 35 spline applications. Shafts up to 31 spline are ideal for street applications with the use of posi-units, Detroit Lockers, and helical gear differentials. It is always recommended to use the largest shaft as possible. If you own a 9" rear end and are considering purchasing a differential for a OEM case, then you should always upgrade from 28 to 31 spline components. The axles are identical in price and often the differentials are similar in cost. Although our 28 spline Alloy axle is stronger than OEM 28 spline, 31 spline axles are 38% stronger. We strongly recommend an upgrade to 31 spline axles for street applications.

Strange Alloy 33 and 35-spline axles are able to withstand even higher torque and bending loads. 35-spline alloy axles are ideal for street and strip applications and may be used with Detroit Lockers, helical gear differentials and spools. Spools are for Drag Racing only and should never be used on the street.

Strange also offers alloy replacement c-clip style axles for many OEM applications. Call today to discuss your requirements.

STRANGE ALLOY AXLES

A3100 Strange Alloy induction hardened axles Ford 28, 31, 33 spline / Mopar 30 spline/ GM 30, 33 spline. Drilled and tapped for your choice of bolt circle- pair... \$324

A3500 Strange Alloy 35 spline induction hardened axles. Drilled and tapped for your choice of bolt circle- pair... \$324

A1004 Additional charge for access hole or third bolt circle- pair... \$16



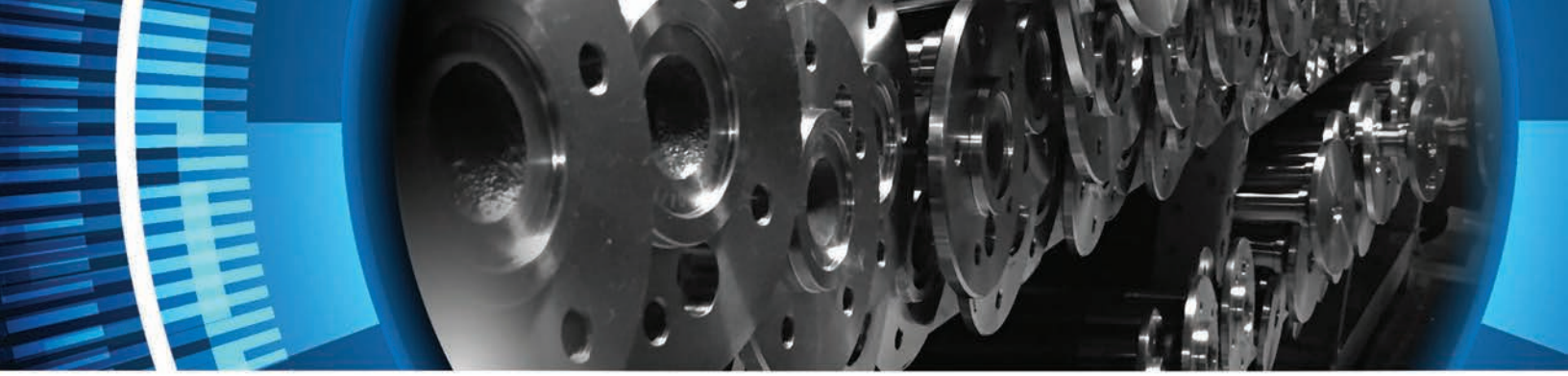

STRANGE ALLOY AXLE PACKAGES FOR MOPAR

Alloy axle packages are easily configured to a wide range of applications and are customized for your vehicle. Strange has combined integrated components at money saving prices. As with all Strange packages, Alloy Axle packages are designed to ease installation saving you time & money.



P3104 Ford 28, 31, Chevy or Mopar 30 spline axles, axle bearings, retaining plates, and 2" or 3" (1/2-20) stud kit..... \$421

P310458 P3104 with upgrade to 5/8" stud kit... \$481

P3504 Alloy 35 spline axles, bearings, retaining plates, and 2" or 3" (1/2-20) stud kit..... \$421

P350458 P3504 with upgrade to 5/8" stud kit... \$481

AXLES

ALLOY AXLE PACKAGES

STRANGE 35 SPLINE ALLOY AXLE & SPOOL PACKAGES FOR FORD, GM, MOPAR AND MORE...

Alloy axle & spool packages are easily configured to a wide range of applications and are customized for your vehicle. Strange has combined integrated components at money saving prices. As with all Strange packages, Alloy Axle packages are designed to ease installation saving you time & money

- P3502S Strange 35 spline Alloy axles, axle bearings, 2" or 3" (1/2-20) stud kit, and Lightweight Pro Steel Spool... \$554
- P350258S With upgrade to 5/8" stud kit... \$614
- P3504S Strange 35 spline Alloy axles, axle bearings, retaining plates, 2" or 3" (1/2-20) stud kit, and Lightweight Pro Steel Spool... \$571
- P350458S With upgrade to 5/8" stud kit... \$631



AXLES

PRO RACE AXLES



- Designed for your custom drag racing application
- Involute splines for increased strength
- Forged from Hy-Tuf for optimal grain structure
- Thru-hardened for superior torsional strength
- Contingency programs
- Five year replacement guarantee for 33, 35 and 40-spline axles
- Most orders shipped within 2 days

STRANGE PRO RACE AXLES are forged from Hy-Tuf alloy steel that was originally developed for highly stressed landing gear in military aircrafts. The material is in the class of Ultra Strength alloys and contains low carbon, high manganese, high nickel, and high molybdenum steel. Pro racing axles are thru-hardened allowing for a Drag Racing shaft with an exceptionally high, 240,000 PSI, tensile strength while retaining ductility.

Strange Engineering stocks a variety of completely finished axles for specific applications. After 50 years of manufacturing axles, we know which applications are most common and there is no reason to charge you extra for priority service. If your requirements cannot be met by our extensive inventory, we will custom manufacture your axle at no additional cost. Strange Pro Race axles are the best value on the market today. That's why more drag racing competitors rely on Strange axles than all other brands combined! Contact a Strange sales technician to discuss your specific application.

- A1000 Pro Race Hy-Tuf axles, any length, and any spline up to 35
Choice of bolt circle - Tapped for 1/2" or 5/8" screw-in studs- pair... \$429
- A1003 Lightened axle flange - Five 1" round lightening holes- pair... \$28
- A1004 Additional charge for access hole or third bolt circle- pair..... \$16
- A1005 Lighten shaft and flange - 35 spline axles shafts gun-drilled with .875" bore
Maximum length is 20" - Flanges machined with five round holes- pair... \$129
- A1006 Ultra Lite flange - Pocket mill flange in solid or gun-drilled axles... \$75

Gun-drilled axles with A1006 option also are lightened underneath the Strange logo
See picture on next page

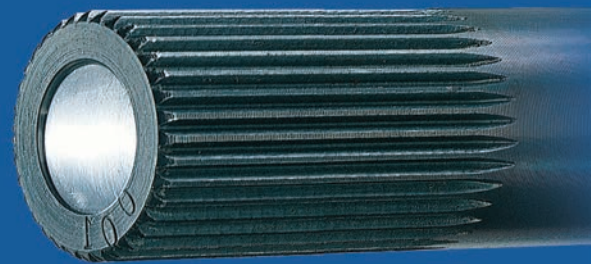

STRANGE GUN-DRILLED AXLES were created to reduce rotating weight. Gun-drilling is a process where the core of the axle is removed leaving a .875" hole through the entire length of the shaft. Each gun-drilled axle is further lightened by eliminating axle flange material with five 1" diameter holes. A 35 spline gun-drilled axle is 25.6% lighter than a solid 35 spline axle and can be used for non-blown cars weighing under 1,850 lbs.

Strange 40 spline gun-drilled axles can withstand the abuse of drag racing vehicles weighing 3,500 lbs. and with quarter mile elapsed time slips under seven seconds. Strange 40 spline gun-drilled axles are 10% lighter than 35 spline solid axles and an astonishing 54% stronger. The Strange 40 spline gun-drilled axle is truly the ultimate drag racing axle.

A solid axle shaft is stronger than an equivalent in diameter gun-drilled shaft. When weight is not an issue, a gun-drilled axle should not be used.



Strange Ultra Light flange for solid axle is pictured above



Strange Ultra Light axle for gun-drilled axle shown above



Strange 40 Spline Pro Race Axles

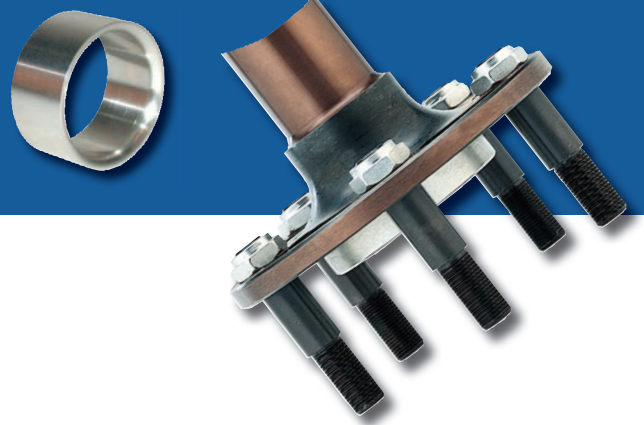

A2000 Pro Race Hy-Tuf 40 spline gun-drilled axles, any length up to 30", choice of bolt circle, with five 1" round lightening holes in flange, tapped for 1/2" or 5/8" screw-in studs- pair..... \$554

A2100 Pro Race Hy-Tuf 40-spline solid axles, any length up to 35", choice of bolt circle, with five 1" round lightening holes in flange, tapped for 1/2" or 5/8" screw-in studs- pair..... \$469

A1006 Ultra Lite flange - Pocket mill axle flange for solid or gun-drilled axles... \$75

Gun-drilled axles with A1006 option are further lightened underneath the Strange logo removing an additional 1.50 lbs. compared to five 1" holes

ADVANTAGES OF THE STRANGE RADIUS RING

The axle bearing shoulder, where the bearing rests against the axle, encounters a tremendous amount of stress. The load, compared to OEM axles, is compounded by the use of slicks, larger diameter tires, aggressive launches, and tire shake. This area can be strengthened by increasing the diameter of the bearing surface and minimizing the distance from the axle bearing shoulder to the outside of the axle flange.

When we developed our 40 spline axle, the bearing surface OD was made to a giant 1.7735". By using a special stainless steel ring, we were able to accomplish three important goals. Increase the radius of the axle bearing shoulder, drastically reduce stress concentrations, minimize the distance from the bearing shoulder to the outside of the axle flange, and set axle offset to match the brake kit.



*2005-2014 kits include billet aluminum caliper mounts - Eliminating modifications that compromise integrity of the OEM mount
5/8" stud kit option limited to A1027 for all axle packages with eliminator kits due to clearance requirements*

STRANGE 28 TO 35 SPLINE PRO RACE AXLE PACKAGES FOR MOPAR

P1007 Pro Race Hy-Tuf axles any length, splined up to 35, choice of bolt circle, axle bearings, and 2" or 3" (1/2-20) stud kit..... \$470

P100858 P1008 with upgrade to 5/8" stud kit... \$534

A1006 Ultra Lite flange - Pocket mill axle flange for solid or gun-drilled axles- pair..... \$75

P100758 P1007 with upgrade to 5/8" stud kit... \$524

P1008 Pro Race Hy-Tuf axles any length, splined up to 35, choice of bolt circle, axle bearings, retainer plates, and 2" or 3" (1/2-20) stud kit..... \$480



AXLES

40 SPLINE PRO RACE AXLE PACKAGES



40 SPLINE PRO RACE AXLE PACKAGES

P1014 Lightweight Pro Race Hy-Tuf 40 spline gun-drilled axles with .875" bore, any length up to 32", choice of bolt circle five 1" round lightening holes in flange, A1019 axle bearings, and 5/8" stud kit... \$663

P1016 Pro Race Hy-Tuf 40 spline solid axles - any length up to 35", choice of bolt circle five 1" round lightening holes in flange, A1019 axle bearings, and 5/8" stud kit... \$582



AXLES

PRO RACE AXLE & SPOOL PACKAGES & AXLE ACCESSORIES



P2005

STRANGE PRO RACE HY-TUF AXLE AND LIGHTWEIGHT STEEL SPOOL PACKAGES

Easily configured to a wide range of applications.
Custom designed for your vehicle at money saving prices!

- | | |
|---------|---|
| P2005 | Pro Race Hy-Tuf axles any length, 33 or 35-spline, choice of bolt circle, axle bearings, 2" or 3" (1/2-20) stud kit, retaining plates, and Lightweight Pro Steel spool..... \$629 |
| P200558 | With upgrade to 5/8" stud kit..... \$683 |
| P2007 | Pro Race Hy-Tuf axles any length, 33 or 35-spline, choice of bolt circle, axle bearings, 2" or 3" (1/2-20) stud kit, and Lightweight Pro Steel spool..... \$609 |
| P200758 | With upgrade to 5/8" stud kit..... \$663 |



P2017

P2015

Lightweight Pro Race Hy-Tuf 40 spline gun-drilled axles - .875" bore, any length up to 30" choice of bolt circle, five 1" round lightening holes in axle flange, A1019 axle bearings, 5/8" stud kit and Lightweight Pro Steel spool..... \$890

P2017

Pro Race Hy-Tuf 40 spline solid axles - any length up to 35" choice of bolt circle, five 1" round lightening holes in axle flange, A1019 axle bearings, 5/8" stud kit and Lightweight Pro Steel spool)..... \$800



**OPTIONAL ULTRA LIGHT
FLANGE AVAILABLE FOR ALL
STRANGE AXLE PACKAGES
A1006 ADD \$75**

AXLES

PRO RACE AXLE & SPOOL PACKAGES & AXLE ACCESSORIES

STRANGE STUD KITS

Strange offers the choice of two types of 5/8" stud kits.

Our traditional A1027 stud kit features premium bolts & adjustable .875" long sleeves. This the lightest stud kit.

In addition, we offer five lengths of chrome moly stud kits. Ensure dimension "A" is able to fully engage into your wheel. This needs to be slightly greater than the combined thickness of the disc brake hat or drum and the thickness of the wheel.

Every 5/8" stud kit includes aluminum anti-marring washers that protect the wheel from the nut. Anti-marring washers are offered in .250", .4375" and .688" widths. The .4375" washer is our standard washer thickness. You can choose to substitute with the .250" by adding "S" at the end of the part number, or "L" for the .688" washers.

Strange 1/2" stud kits are offered in 2" and 3" lengths. The stud length refers to the threaded portion of the stud. To determine the usable thread that will protrude from the axle flange, subtract the thickness of the axle flange and an additional .0625" for the washer. 1/2" stud kits are designed for 1/2"-20 lug nuts - Not included in kits.

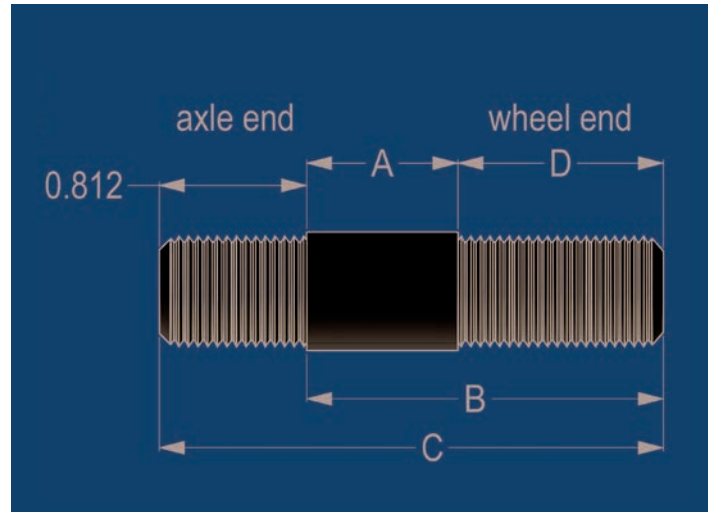

STRANGE 1/2" STUD KITS

A1025 2" screw-in stud kit for Strange axles (1/2"-20)
Grade 8 bolts and washers- 10 of each..... \$21

A1026 3" screw-in stud kit for Strange axles (1/2"-20)
Grade 8 bolts and washers- 10 of each..... \$21



CHROME MOLY 5/8" STUD KITS

A1037 3" screw-in stud kit for Strange axles (5/8"-18)
Grade 8 bolts with .875" adjustable sleeves,
lug nuts, .4375" aluminum washers, and wrench... \$90



A1037



A1027

TRADITIONAL 5/8" STUD KITS

A1027 3" screw-in stud kit for Strange axles (5/8"-18)
Grade 8 bolts with .875" adjustable sleeves,
lug nuts, .4375" aluminum washers, and wrench... \$90

STRANGE CHROME-MOLY 5/8" STUD KITS

A1036 Strange chrome-moly 5/8" stud kit
Lug nuts, .250" aluminum washers, and locking nuts
A = .775", B = 1.550", C = 2.362", D = .775"

A1037 Strange chrome-moly 5/8" stud kit
Lug nuts, .4375" aluminum washers, and locking nuts
A = .875", B = 2.063", C = 2.875", D = 1.188"

A1037MD Strange chrome-moly 5/8" stud kit
Lug nuts, .4375" aluminum washers, and locking nuts
A = .875", B = 1.760", C = 2.572", D = .885"

A1038 Strange chrome-moly 5/8" stud kit
Lug nuts, .4375" aluminum washers, and locking nuts
A = 1.187", B = 2.375", C = 3.187", D = 1.188"

A1039 Strange chrome-moly 5/8" stud kit
Lug nuts, .4375" aluminum washers, and locking nuts
A = 1.500", B = 2.688", C = 3.500", D = 1.188"

A1041 Strange chrome-moly 5/8" stud kit
Lug nuts, .4375" aluminum washers, and locking nuts
A = 1.875", B = 3.125", C = 4.00", D = 1.250"



L7010NX
Aluminum 5/8" lug nut
With integral washer.. \$9 ea

ALL STRANGE 5/8" STUD KITS - \$90

5/8" stud kits contain .4375" washers unless otherwise noted

Add "S" to end of part number for .250" or "L" for .688"

AXLES

ACCESSORIES



AXLE BEARINGS

- A1013** Timken tapered axle bearing, locking ring & outboard seal
1.562" bore for 3.150 ID housing end- ea... \$35
- A1019** Ball style axle bearing and locking ring
1.772" bore for 3.150" ID housing end- ea... \$35
- A1020** Ball style axle bearing and locking ring
1.531" bore for 3.150" ID housing end- ea... \$35
- A1021** Ball style axle bearing and locking ring
1.562" bore for 3.150" ID housing end- ea... \$35
- A1022** Mopar non-adjustable axle bearing, locking ring, spirolox,
retainer plate - 1.562" bore for 2.875" housing end- ea... \$40
- A10220B** Mopar non-adjustable axle bearing, locking ring, fixed
retainer plate - 1.562" bore for 2.875" housing end- ea... \$40

RETAINER PLATES

- A1015** Oldsmobile retainer plate- ea... \$13
- A1016** Early Big Ford retainer plate
with 1/2" bolt holes- ea... \$13
- A1018** Late big Ford retainer plate
with 3/8" bolt holes- ea... \$13



GEARS

US STRANGE, SPICER, RICHMOND, MOTIVE GEAR PERFORMANCE

8620 PRO STREET / STANDARD

GEAR SETS: The combination of 8620 steel and precise heat treatment results in a gear set with the strength and hardness necessary for excellent life in circle track, street and some Drag Racing applications.

9310 DRAG RACE / PRO GEAR SETS: For Drag Racing ONLY! High nickel 9310 steel gear sets are softer by design to absorb the high impact shock loads that occur in many Drag Racing classes.



GEAR SET BREAK-IN: Pro Street / Standard gear sets must be broken-in properly to ensure maximum life and quiet operation. During this process, the gear set is heat cycled and lapped. A new ring and pinion will generate a lot of heat due to friction. If temperatures get too high, they will alter the surface hardness of the material leading to early failure.

LUBRICATION: The differential will best determine the proper gear lube. Always follow the recommendations of the differential manufacturer. In general, clutch style posi units or cone type systems require a quality petroleum based gear lube along with a bottle of friction modifier. For helical gear units, use the petroleum based fluid only. Always check before using any synthetic fluids as irreversible damage may occur. If using a spool, the choice is yours between petroleum and synthetic.

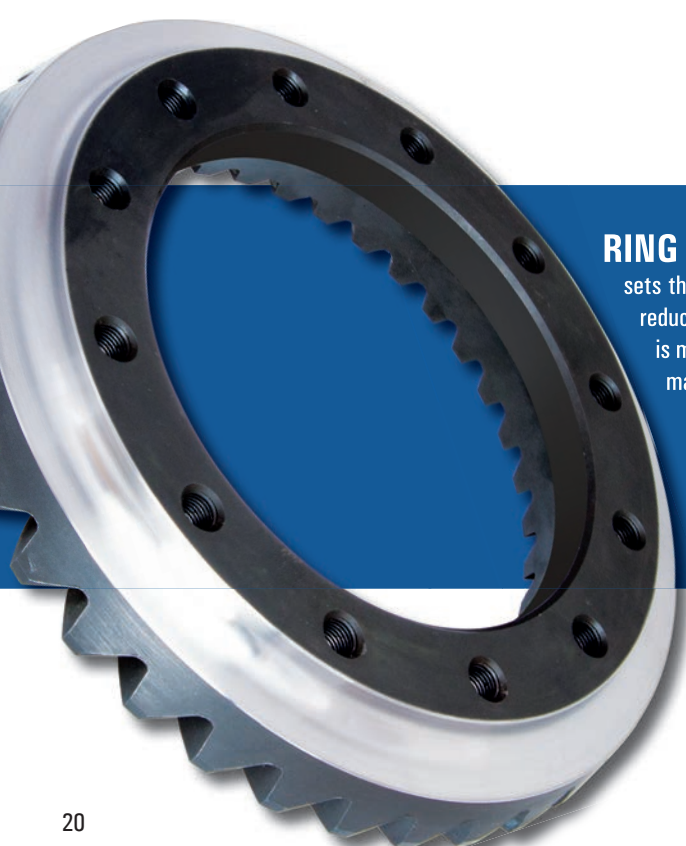

RING GEAR LIGHTENING SERVICE: Ring gear lightening is offered for all gear sets that can benefit from the process. The ring gear is machined to reduce rotating weight. Weight reduction ranges from .75 lbs. to 2.75 lbs. depending on ratio and the rear end it fits. Each ring gear is machined with a generous radius and the weight reduction will not reduce gear life for the vast majority of applications.

D3596	Lighten purchased new ring gear.....	\$75
D3597	Lighten customer supplied new ring gear.....	\$100



GEAR RATIO CALCULATION

$$\text{Revolutions Per Minute} = \frac{336 \times \text{Gear Ratio} \times \text{MPH}}{\text{Tire Diameter}}$$

$$\text{Miles Per Hour} = \frac{\text{Tire Diameter} \times \text{RPM}}{336 \times \text{Gear Ratio}}$$

$$\text{Gear Ratio} = \frac{\text{Tire Diameter} \times \text{RPM}}{336 \times \text{MPH}}$$

$$\text{Tire Diameter} = \frac{336 \times \text{Gear Ratio} \times \text{MPH}}{\text{RPM}}$$

APPROXIMATE 1/4 MILE ET TO MPH (without power adders or throttle stop)

13.00 - 100 mph
12.50 - 105 mph

12.00 - 108 mph
11.50 - 116 mph

11.00 - 121 mph
10.50 - 127 mph

10.00 - 132 mph
9.50 - 139 mph

9.00 - 147 mph
8.50 - 158 mph

8.00 - 165 mph
7.50 - 176 mph

STRANGE MASTER INSTALLATION KITS: When investing in the new gear set and/or carrier, it is important to use new bearings, seals, ring gear bolts, and other essential installation components. New installation components will reduce the chance of gear set and component failure.

Strange Engineering offers master installation kits for most gear set applications. Master installation kits feature Timken bearings and races, ring gear bolts, shims, seal, pinion nut, gasket or sealer, brush, marking compound, and crush collar if required.



STRANGE BASIC INSTALLATION KITS: Basic kits include ring gear bolts, shims, seal, pinion nut, gasket or sealer, brush, marking compound, and crush collar if required. Bearings and races are not included.

MICROBLUE: This two step process greatly reduces friction between the ring and pinion. The REM stage removes the rough OEM machining marks. Afterwards, it receives the MicroBlue coating which improves the wetting characteristics of the differential fluid. This makes the gear set "slipperier" in gear oil. Less heat and friction add up to more available horsepower and longer gear life. This process is also available for bearings and races in installation kits.

D3598G	MicroBlue Gear Set.....	\$220
D3598B	Pinion & side (bearings/races).....	\$71
D3598BT	Pinion & side (bearings/races), and tail bearing.....	\$88



GEARS

US GEAR, SPICER, RICHMOND, MOTIVE GEAR PERFORMANCE CHRYSLER, DODGE & MOPAR

DANA 60 STANDARD GEAR SETS

D3550	Spicer	3.54 ratio 3 Series.....	\$330
D3551	Spicer	3.73 ratio 3 Series.....	\$221
D3552	Spicer	4.10 ratio 3 Series.....	\$221
D3570	Richmond	4.10 ratio 3 Series.....	\$238
RS05897430H	Hoosier	4.30 ratio 3 Series.....	\$225

D3553	Spicer	4.56 ratio 5 Series.....	\$209
RSD60488	Richmond	4.88 ratio 5 Series.....	\$248
RSD60513	Richmond	5.13 ratio 5 Series.....	\$251
D3555	Richmond	5.38 ratio 5 Series.....	\$240

* 3-series fits 4.10 & numerically lower carrier

* 5-series fits 4.56 & numerically higher carrier

DANA 60 DRAG RACE / PRO GEAR SETS (5-SERIES)

RP05997410US	US Gear	4.10 ratio.....	Call
RP05997410	Motive	4.10 ratio.....	\$369
RPD60410	Richmond	4.10 ratio.....	\$388
RP05997430US	US Gear	4.30 ratio.....	\$358
RP05997456US	US Gear	4.56 ratio.....	Call
RP05997456	Motive	4.56 ratio.....	\$371
RPD60456	Richmond	4.56 ratio.....	\$390
RP05997488US	US Gear	4.88 ratio.....	Call
RP05997488	Motive	4.88 ratio.....	\$371

RPD60488	Richmond	4.88 ratio.....	\$390
RP05997514	Motive	5.14 ratio.....	\$345
RP05997538US	US Gear	5.38 ratio.....	Call
RPD60538	Richmond	5.38 ratio.....	\$360
RP05997557US	US Gear	5.57 ratio.....	Call
RP05997586US	US Gear	5.86 ratio.....	Call
RP05997617US	US Gear	6.17 ratio.....	Call
RPD60617	Richmond	6.17 ratio.....	\$408

DANA 60 / STRANGE S60 INSTALLATION KITS

D3512	Strange S60 Master installation kit.....	\$160
D3513	OEM Dana 60 Master installation kit.....	\$180
D3525	Front pinion bearing.....	\$18
D3526	Front pinion race.....	\$12
D3527	Rear pinion bearing.....	\$25
D3528	Rear pinion race.....	\$14
D1592	Side bearings & races for Strange S60.....	\$47

D1580	Side bearings & races for OEM Dana 60.....	\$69
D3502A	Pinion seal.....	\$9
D3502	Pinion seal, pinion nut, & washer.....	\$10
D3504	Ring gear bolts.....	\$11
D3503	Cover gasket, pinion nut, & shim kit.....	\$36
D3508	Cover gasket.....	\$9
D3508F	Cover gasket- Fel-Pro High Performance.....	\$18



MOPAR 8.75" (742 CASE) STANDARD GEAR SETS AND INSTALLATION KITS

- 10 bolt Drop-Out
- Ring gear = 8.75"
- Pinion shaft = 1.750" (straight pinion shaft)
- Pinion spline = 10
- 3/8"-24 LH bolt holes

Barracuda 64-68
 Belvedere 57-68
 B200, B250, W100 & W150 65-68
 Chrysler 300 57-68
 Challenger 68 only

Charger (Daytona) 66-68
 Coronet 63-68
 Dart, Swinger 66-68
 Fury 57-68
 Imperial, New Yorker 57-68

Monaco, Polara 63-68
 Road Runner 68 only
 Satellite 68 only
 Super Bee 68 only
 Valiant 60-68

RS03887373E	Motive	3.73 ratio.....	\$258	RS03887430E	Motive	4.30 ratio.....	\$219
RS03887391E	Motive	3.91 ratio.....	\$261	RS03887486E	Motive	4.86 ratio.....	\$219

R5261	Master installation kit for 742 case *	\$119	R5260	Basic installation kit.....	\$68
R5261SP	Master installation kit for 742 case **	\$119	R5258	Ring gear bolts ***	\$18

* For OEM carrier ** For Strange spool or Auburn carrier *** Included in kits

MOPAR 8.75" (489 CASE) STANDARD GEAR SETS AND INSTALLATION KITS

- 10 bolt Drop-Out
- Ring gear = 8.75"
- Pinion shaft = 1.875"
- Pinion spline = 29
- 3/8"-24 LH bolt holes

Barracuda 69-73
 Belvedere 69-70
 B200, B250, W100 & W150 69-73
 Chrysler 300 69-73
 Challenger 70-73

Charger (Daytona) 69-73
 Dart, Swinger 69-73
 Fury 69-73
 Newport, New Yorker 69-73
 Monaco, Polara 69-73

Road Runner 69-73
 Satellite 69-73
 Super Bee 69-70
 Valiant 69-73

RS03887323LUS	US Gear	3.23 ratio.....	Call	RS03887410LUS	US Strange	4.10 ratio.....	Call
RS03887355LUS	US Gear	3.55 ratio.....	\$265	RS03887410L	Motive	4.10 ratio.....	\$265
RS03887355L	Motive	3.55 ratio.....	\$263	RS03887430LUS	US Gear	4.30 ratio.....	\$265
RS03887373LUS	US Gear	3.73 ratio.....	\$265	RS03887456LUS	US Gear	4.56 ratio.....	\$265
RS03887373L	Motive	3.73 ratio.....	\$265	RS03887456L	Motive	4.56 ratio.....	\$265
RS03887391LUS	US Gear	3.91 ratio.....	\$265	RS03887486LUS	US Gear	4.86 ratio.....	\$265
RS03887391L	Motive	3.91 ratio.....	\$265	RS03887513LUS	US Gear	5.13 ratio.....	\$265

R5266	Master installation kit for 489 case.....	\$119
R5265	Basic Kit.....	\$58
R5258	Ring gear bolts *	\$18
D1584	Side bearings & races for 489 case.....	\$44

* Included in kit



DIFFERENTIALS & SPOOLS

STRANGE, EATON, AUBURN, SPICER US GEAR, HOOSIER, & YUKON

DIFFERENTIALS: Driving down a straight road, the differential allows both axles to turn at the same speed. During a turn, the outer wheel needs to turn faster than the inner wheel since it has to cover a longer path in the same amount of time. If not, the tire will scrub or hop around the

corner. The differential compensates for this condition, by altering the RPM relationship between the two axle shafts. There are several designs that meet this requirement, but accomplish it in different ways.

OPEN DIFFERENTIALS: This is the most basic unit. It uses side gears (internally splined to the axles), engaged with spider gears (shaft mounted to the case). All the gears are in constant mesh. As long as the load remains the same, the gears will remain idle and both axles will turn at the same rate. Once an axle becomes harder to rotate, like the inside tire during a turn, it causes

the spider gears to walk around the held gear and drive the other side gear faster. While it may perform adequately for some applications, it is very sensitive to any variance in loads. If weight is shifted in the vehicle it can cause this condition to occur. An open differential in a performance car is undesirable since it will speed-up the tire with the worst traction.

CLUTCH SYSTEMS: Similar in design as the open, but have a series of friction plates between the side gear and the case. Standard Duty units have them behind one side gear, Heavy Duty have them behind both. There is a spring or springs that apply tension between the case, clutch pack(s), and the side gears. By increasing friction in

this way, it requires more load variation before the clutches release and allow the gears to start rotating and speed-up the outer wheel. The number of plates, their material, and spring pressure will alter the release point. The clutch packs can be replaced when worn-out, but their replacement cost might be prohibitive.

CONE SYSTEMS: The case is machined with tapered bores and the side gears have a mating cone shape on their backside. There is a spring or springs that apply pressure to the side gears causing them to wedge into the case. It also uses spider gears and a cross shaft as above. The operation is much the same as the clutch system, but

utilizes tapered cones instead of clutch packs. Standard Duty units have smaller cones than the Heavy Duty. Larger cones have more surface area resulting in more holding power and longer life. These are non-rebuild-able and must be replaced when worn out.

LOCKERS: A Locker is a mechanical unit that is sensitive to torque application. It will lock (drive both wheels) under acceleration, or unlock (allow the axles to turn at different rates) during coast or deceleration. A very strong piece, since it doesn't use any clutches or cones that can wear out, which made it a good choice for its original truck application. Since driver input mainly determines

whether the unit is locked or not, it can be very frustrating to a driver who is unfamiliar with the operation of the differential. Hard acceleration during a turn will cause the unit to lock and skid the tire. Between lock and unlock, a distinctive "clunk" can be heard. During a properly executed turn, clicking will be audible since locking teeth are allowed to jump each other inside the unit.

HELICAL GEAR UNIT: A helical gear differential is a mechanical unit that, unlike the Locker, offers smooth and progressive power transfer. If one tire begins to slip relative to the other tire, a separating force is created between the pinion gears and side gears. This generates internal friction which slows the spinning wheel

and sends power to the wheel with the most traction. These differentials are comparable to the strength of a Locker, but without its downsides. The Strange 9" S-Trac, due to materials and design, exceed the strength limits of the Locker while offering all the benefits of a helical gear unit.

SPOOL: A spool is one solid part that replaces all components of a differential. It will always turn both axles at the same speed with an equal amount of force. Due to the simplistic design, it is much stronger and lighter than any differential. It also allows the use of larger axles that can handle greater amounts of torque. This makes it the best choice for Drag Racing, Drifting, and other forms of

motorsports that require uninterrupted transfer of power to both wheels. Spools should never be considered for a street application. They are produced in forged steel, forged aluminum, and billet aluminum. Before purchasing an aluminum spool, contact Strange to discuss your particular application.



Spicer Clutch



Eaton Clutch



Strange Clutch

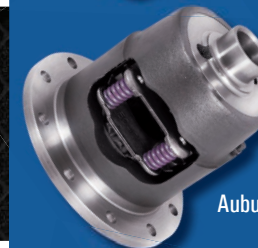

Auburn Cone



Eaton Locker

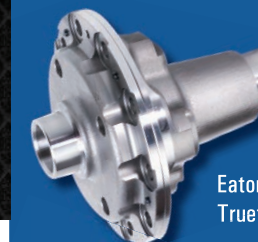

Eaton Helical Truetrack



L/W Steel Spool

DIFFERENTIALS & SPOOLS

STRANGE, EATON, AUBURN, SPICER US GEAR, HOOSIER, & YUKON

DANA 60 / STRANGE S60 / MOPAR 8.75" DIFFERENTIAL

D3537 *	Dana 60 / S60	Spicer	Clutch	35 spline.....	\$425
D3538 **	Dana 60 / S60	Spicer	Clutch	35 spline.....	\$425
D3523 *	Dana 60 / S60	Strange	Helical Gear	35 spline.....	\$750
D3533 *	Dana 60 / S60	Eaton	Helical Gear	35 spline.....	\$750
D3534 **	Dana 60 / S60	Eaton	Helical Gear	35 spline.....	\$750
D3535 *	Dana 60 / S60	Eaton	Locker	35 spline.....	\$750
D3536 **	Dana 60 / S60	Eaton	Locker	35 spline.....	\$750
R542051	Mopar 8.75"	Auburn	H/D Cone	30 spline.....	\$520
D3532T	Mopar 8.75"	Eaton	Helical Gear	30 spline.....	\$600

* 3 series carrier ** 5 series carrier



Spicer Clutch

DANA 60 / STRANGE S60 / MOPAR 8.75" SPOOL

D1547 *	Dana 60 / S60	Strange	L/W Steel Spool	35 spline	13.30 lbs	\$190
D1548 **	Dana 60 / S60	Strange	L/W Steel Spool	35 spline	13.20 lbs	\$190
D1544 *	Dana 60 / S60	Strange	L/W Steel Spool	40 spline	12.05 lbs	\$280
D1546 **	Dana 60 / S60	Strange	L/W Steel Spool	40 spline	12.05 lbs	\$280
D1545 **	Dana 60 / S60	Strange	Aluminum Spool	40 spline	7.00 lbs	\$516
D1556	Mopar 8.75"	Strange	L/W Steel Spool	30 spline	8.95 lbs	\$190
D1557	Mopar 8.75"	Strange	L/W Steel Spool	35 spline	8.35 lbs	\$190
D1566	Mopar 8.75"	Strange	Aluminum Spool	35 spline	4.50 lbs	\$399

* 3 series carrier

** 5 series carrier



L/W Steel Spool

COVERS, CASES & MAIN CAPS

FORD 9" ALUMINUM CASES

Stock covers are stamped from thin sheet metal and are designed to close access to the housing internals while maintaining a leak-free seal. While this is sufficient under normal circumstances, increasing torque and horsepower can create unforeseen forces. The housing wants to flex at the opening where the cover attaches since it is the weakest section of the casting. The main caps are made of cast iron and are relatively thin and brittle. As forces mount and the case begins to deflect, ring and pinion life suffers as the contact pattern changes. Additional stress can lead to broken gear teeth as well as shattered main caps.

Chrome covers are purely for looks. Aluminum covers can be cosmetic, supportive, or both. Supportive covers are thick aluminum which reinforces the opening and makes the case much stiffer. They are also equipped with load bolts that contact the main caps increasing the threshold of when they would flex and break. The "ready for back-brace" LPW covers have additional bolt holes to accept their back-brace kit. This kit utilizes the cover to also support the housing tubes eliminating axle tube flex.

Main caps can be replaced with stronger alternatives, but will need to be fitted to the case. This process involves installing them in the housing so the bores can be measured. Since the bores will now be oversized, the main cap bases require milling to return the bore to the proper size. These caps are made of steel or aluminum. Quality aluminum main caps can be an advantage over steel as it is lighter and easier to machine. Under extreme conditions, such as a broken tooth caught between the ring and pinion, they can allow a little flex that might save the differential or spool from damage. These caps are not required for, and will not fit, a Strange S60 or Strange 12 bolt as they are already equipped with heavy duty main caps.

COVERS / BILLET ALUMINUM MAIN CAPS

Dana 60 / S60

D3505	Spicer plain steel cover	Stock.....	\$29
D3517	Strange S logo aluminum cover	Cosmetic.....	\$75
	Black powder coat finish		
D3509	LPW HD aluminum cover	Supportive.....	\$159
	Ready for back-brace	Chrome moly tubing.....	\$109
D3515	LPW Axle tube back-brace kit	Requires machining.....	\$88
H1122	Strange Dana 60 billet aluminum main caps with bolts		



Strange S logo aluminum cover



LPW HD aluminum cover



LPW HD aluminum cover ready for back-brace



LPW axle tube back-brace kit

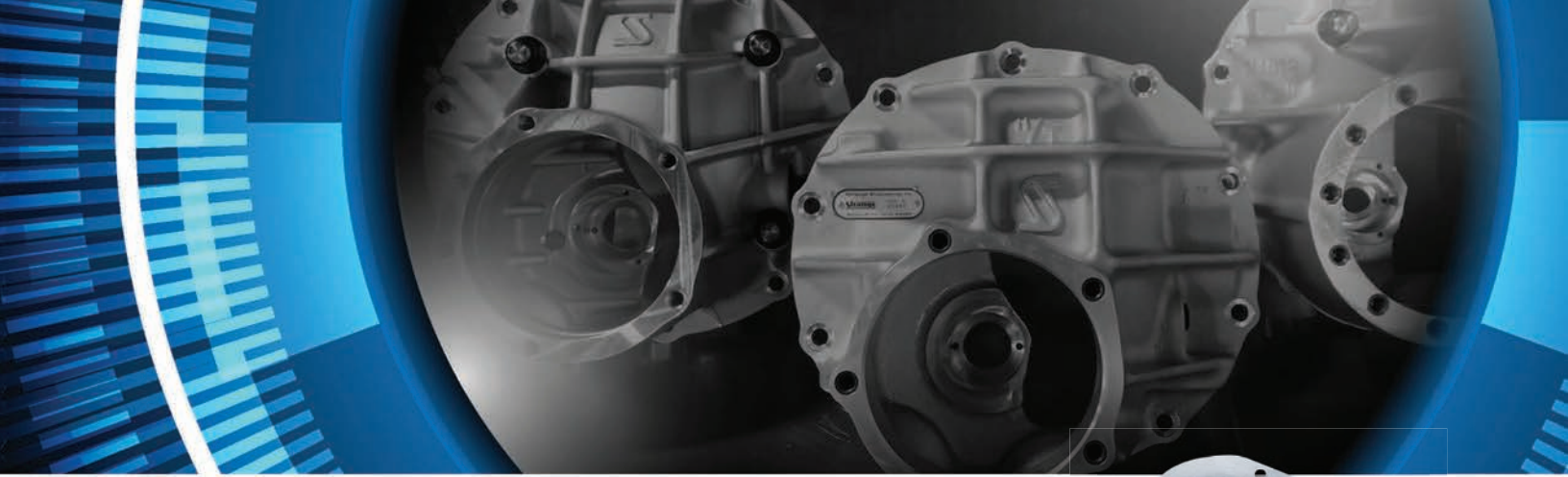

COVERS / BILLET ALUMINUM MAIN CAPS *Continued*

LABOR

H1123 Fit and install Strange billet aluminum main caps
 Labor only- parts extra..... \$90



Steel cover



Chrome cover



Strange Ford 8.8 Billet aluminum main caps with bolts



Strange GM 8.5 Billet aluminum main caps with bolts

S60

BARE HOUSINGS

Bare Castings: The Strange S60 casting is a vast improvement over the factory Dana 60, while still accepting the same components. The casting and oversized main caps are constructed from a proprietary nodular iron which is substantially stronger than cast iron. This has allowed the casting to be made not only thinner and lighter, but also stronger. The heavy duty main caps are fitted with adjuster nuts that eliminate the side carrier shims. Backlash

and preload are adjusted by a turn of a wrench, greatly reducing the time and effort to change a gear or differential. All castings feature a drain plug located at the bottom. Mopar applications have a machined provision to accept factory or aftermarket pinion snubbers. GM F-body applications have the torque arm mounting location cast into the unit, while A-body and G-body feature the upper control mounts.

Welded Housings: All below housings begin with the S60 bare casting as described above. The 3" O.D. mild steel tubing, .250" wall thickness, is pressed deep into the casting. A welding fixture is attached and the tubes are welded 360 degrees around the outside of the casting and plug welded. The

mounts are positioned by the jig and welded to the tubes. The housing ends are installed after all other welding is complete, ensuring perfect alignment with the carrier. An optional satin black powdercoat finish is available on completely welded housings.

Housing Tubed: The S60 casting is fitted with 3"x.250" wall mild steel tubing and welded & plugged as described above. A housing like this is for a builder that will be installing their own mounts and may also trim the

tubing further. An alignment jig will be required to install the housing ends after all other welding has been completed.

Housing with Ends- no mounts: The S60 casting is fitted with 3" .250 wall mild steel tubing and fixture welded with your choice of housing ends. Since the builder will be installing their own mounts, extreme

care must be taken during the welding process as housing end alignment can be compromised. An alignment jig should be used afterwards to ensure that warping did not occur.

Housing with Mounts- no ends: The S60 casting is fitted with 3" .250 wall mild steel tubing and fixture welded with your choice of mounts. A builder might order this if they are unsure of the final width, or already has housing ends and an alignment jig. It may also be the base for a

housing that will use a floater kit. Strange floater spindles can be fitted and welded for an additional charge. A fully welded housing with spindles can also be ordered with an optional satin black powdercoat finish.

Housing with Ends and Mounts: The S60 casting is fitted with 3" .250 wall mild steel tubing and fixture welded with your choice of mounts and housing ends. This configuration is the safest way to maintain

the proper alignment since welding of the housing ends is always our last operation. An optional satin black powdercoat finish is also available.

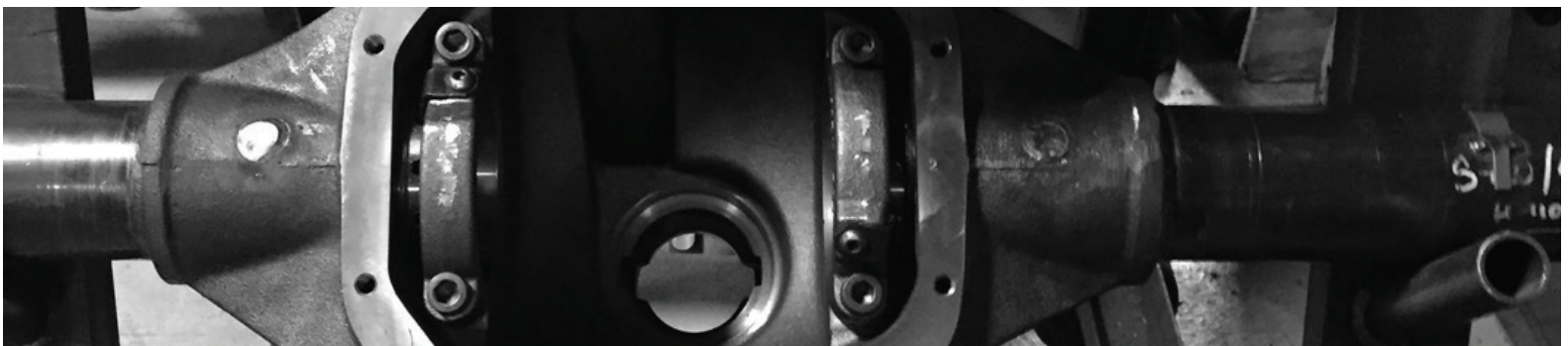

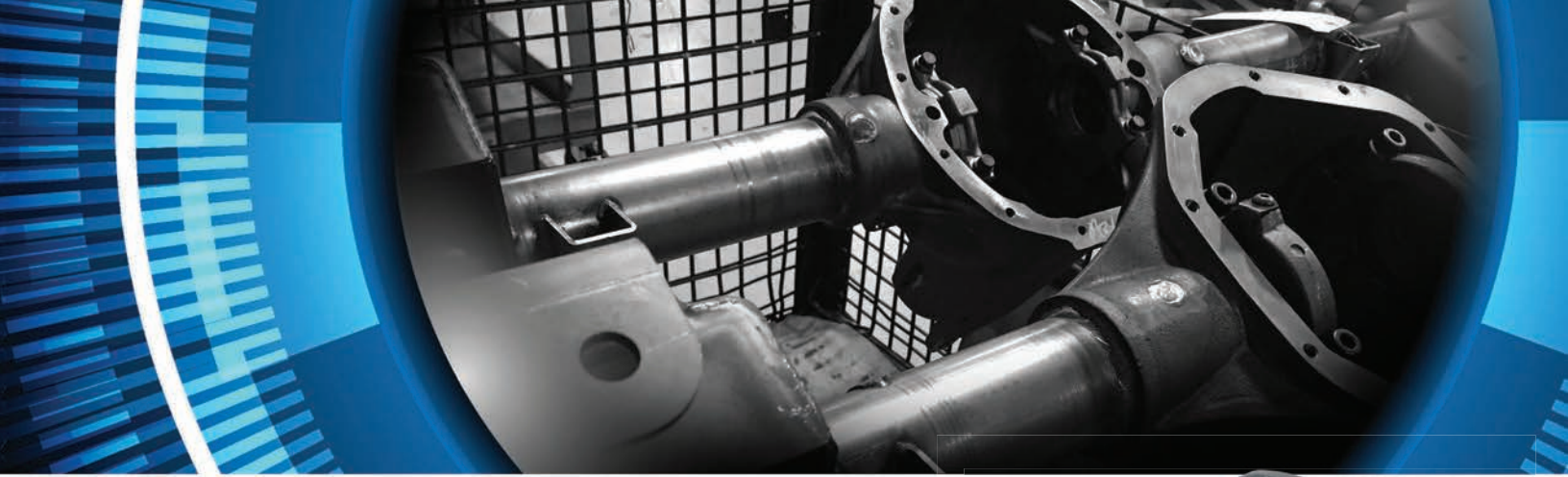

H1109A* Bare Mopar casting for use with 3" O.D. tubes

H60* Mopar casting tubed- No ends or mounts \$575

H60E* Mopar casting with ends- No mounts \$665

H60L Mopar casting with leaf spring mounts- No ends \$695

H60LE Mopar casting with leaf spring mounts, and ends \$785

**Can be used for Mopar or any leaf spring application*

Options

H1199P-BLK Powder coat housing satin black \$159

H1130SF Install Pro Touring floater spindles- Labor only \$150

H1109D Adjuster nut wrench for S60 \$37

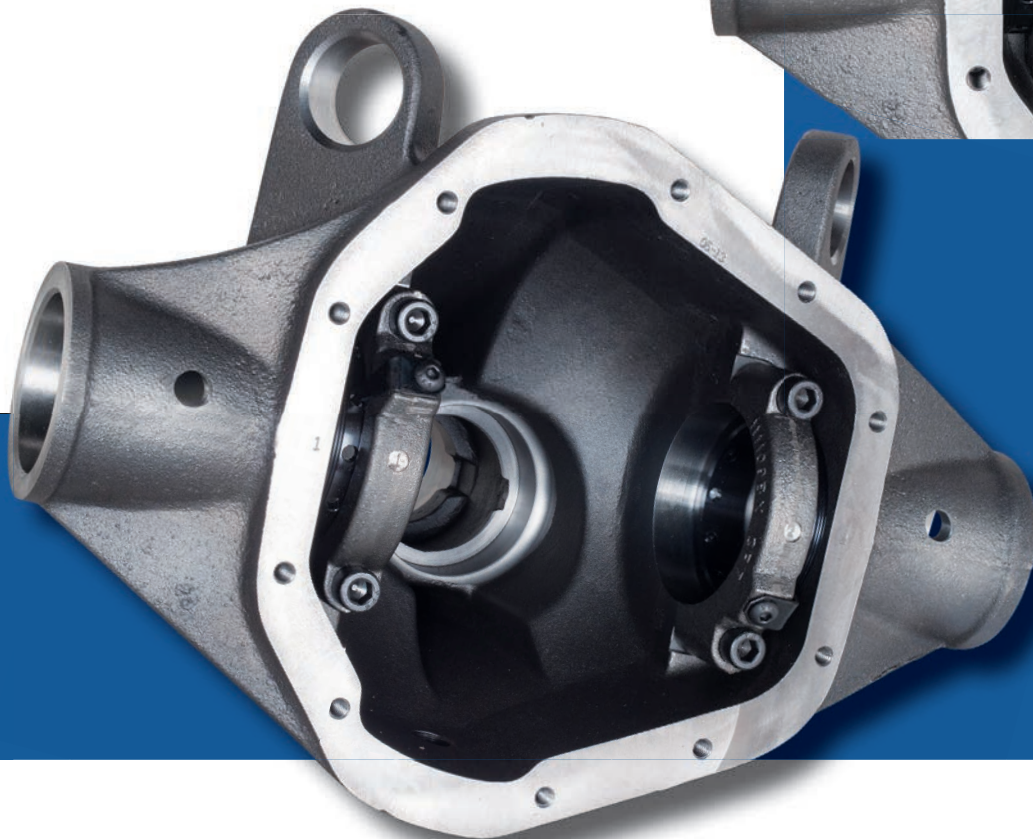
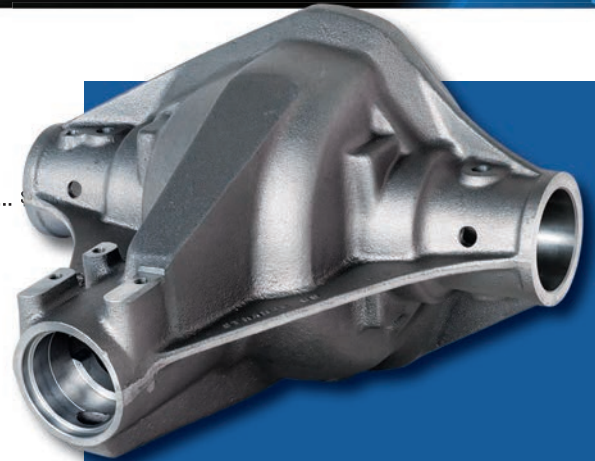

HOUSING ENDS & COMPONENTS

Housing Ends: Strange housing ends are machined from MADE IN THE USA forged steel. These premium grade ends are ideal for a new or existing housing that needs to be narrowed. They provide an optimal mounting surface for the brakes to keep in proper alignment with the axle bearing. These housing ends are designed to be easily butt welded with the proper

equipment. An alignment bar is required to properly install any housing ends. Many ends are now designed to accept an inner seal. This arrangement might require a specific seal and locking collar for the axle bearing. Contact a Strange representative if you intend to use an inner seal to discuss your intentions.

HOUSING END IDENTIFICATION CHART

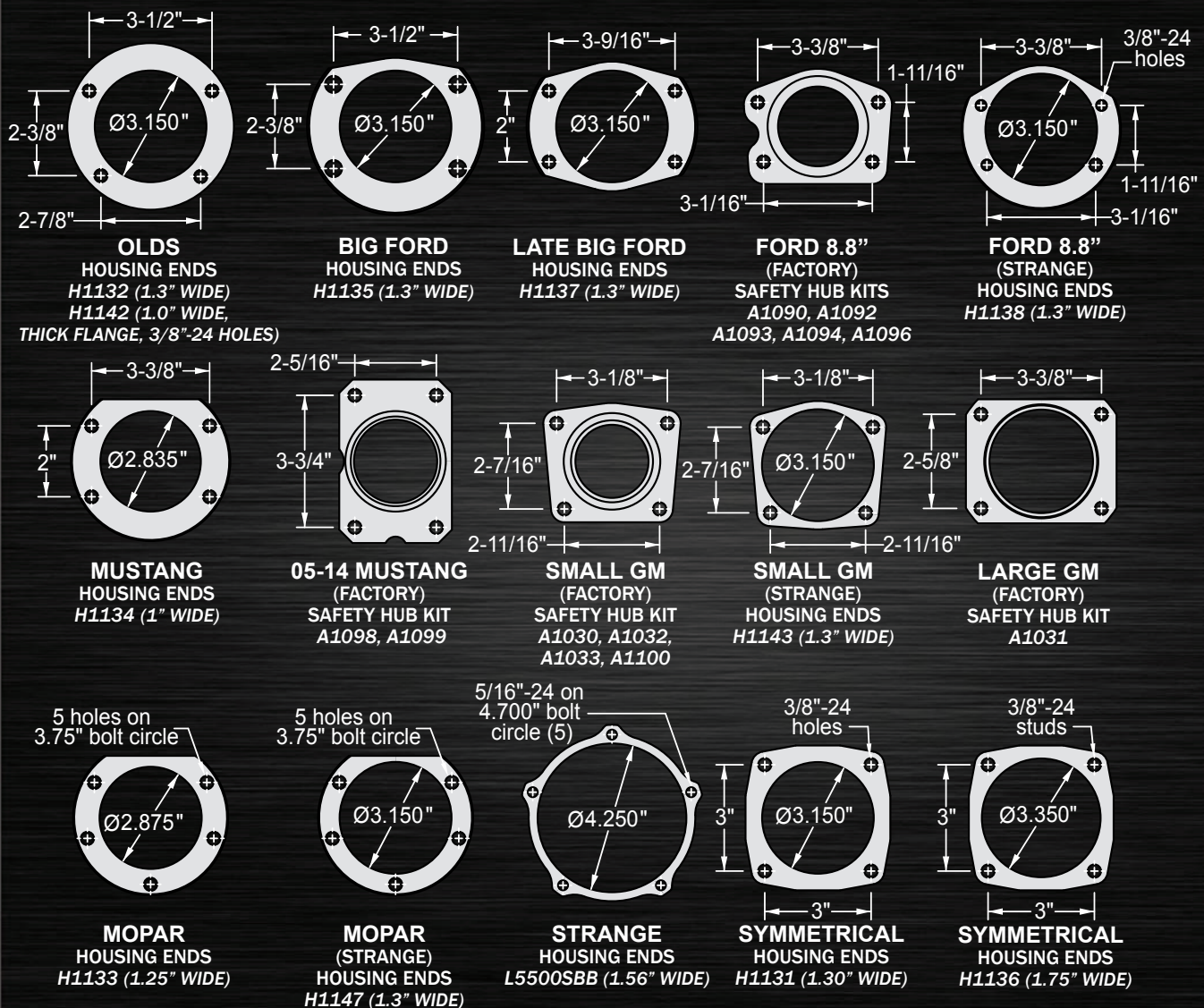



H1132	Olds housing ends	3.150 bore	3/8 holes	1.300" wide	\$89
H1133	Mopar housing ends	2.875 bore	3/8 holes	1.250" wide	\$89
H1147*	Mopar housing ends (special bore)	3.150 bore	3/8 holes	1.300" wide	\$89
H1135	Big Ford housing ends	3.150 bore	1/2 holes	1.300" wide	\$89
H1137	Late Big Ford housing ends	3.150 bore	3/8 holes	1.300" wide	\$89

* Requires custom axles made specifically for this end

**Requires custom axles & B1706MC kit

B1300HSTKIT	3/8" housing end tee bolt kit- includes washers and lock nuts for 8 holes	\$31
H1133STKIT	3/8" housing end tee bolt kit- includes washers and lock nuts for 10 holes	\$38
H1135STKIT	1/2" housing end tee bolt kit- includes washers and lock nuts for 8 holes	\$46

D3508	Fel Pro S60 / Dana 60 cover gasket	\$9
D3508F**	Fel Pro S60 / Dana 60 high performance Teflon gasket	\$18

**Do not use sealer with this gasket



S60 BOLT-IN REAR ENDS

OVERVIEW: The Strange S60 is a vast improvement over a factory Dana 60, while still accepting the same components. The casting and oversized main caps are constructed from a proprietary nodular iron which is substantially stronger than cast iron. This has allowed the casting to be made not only thinner and lighter, but also stronger. The heavy duty main caps are fitted with adjuster nuts that eliminate the side carrier shims. Backlash and preload are adjusted by a turn of a wrench, greatly reducing the time and effort to change a gear or differential. The 9.750" ring gear can endure a tremendous amount of abuse- equal to a 9" Ford at a fraction of the price. It is also more

efficient, taking less horsepower to drive the ring and pinion. The S60 weighs 15 lbs. more than a comparable 9" rear end, and only 20-25 lbs. more than an aftermarket 12-bolt. The S60 rear end is equipped with 35-spline axle shafts without costly upgrades. All castings feature a drain plug located at the bottom. Mopar applications have a machined provision to accept factory or aftermarket pinion snubbers. GM F-body applications have the torque arm mounting location cast into the unit, while A-body and G-body feature integrated upper control mounts. The HD 1350 series pinion yoke is larger than any factory yoke and needs to be accounted for when ordering the driveshaft.

STREET/TRACK: The S60 is equipped with a Spicer Trac-lock (clutch style) posi unit, Standard gear set, 35 spline Alloy axles, 7/16" or 1/2" wheel studs, HD 1350 series yoke, u-bolt kit, and steel rear cover. The Trac-lock is designed for street use in vehicles that will not be raced. The optional Truetrack (helical gear) differential is a great choice for a Street / Track applications. Gear ratio choices are 3.54, 3.73, 4.10, 4.30, 4.56, 4.88, 5.13, & 5.38. Upgrades are available to the differential and wheel studs. Options include a chrome moly 1350 series yoke, Strange aluminum black powder coated cover, LPW HD aluminum cover, and satin black powder coated housing. The steel cover would also be powder coated when this option is ordered.

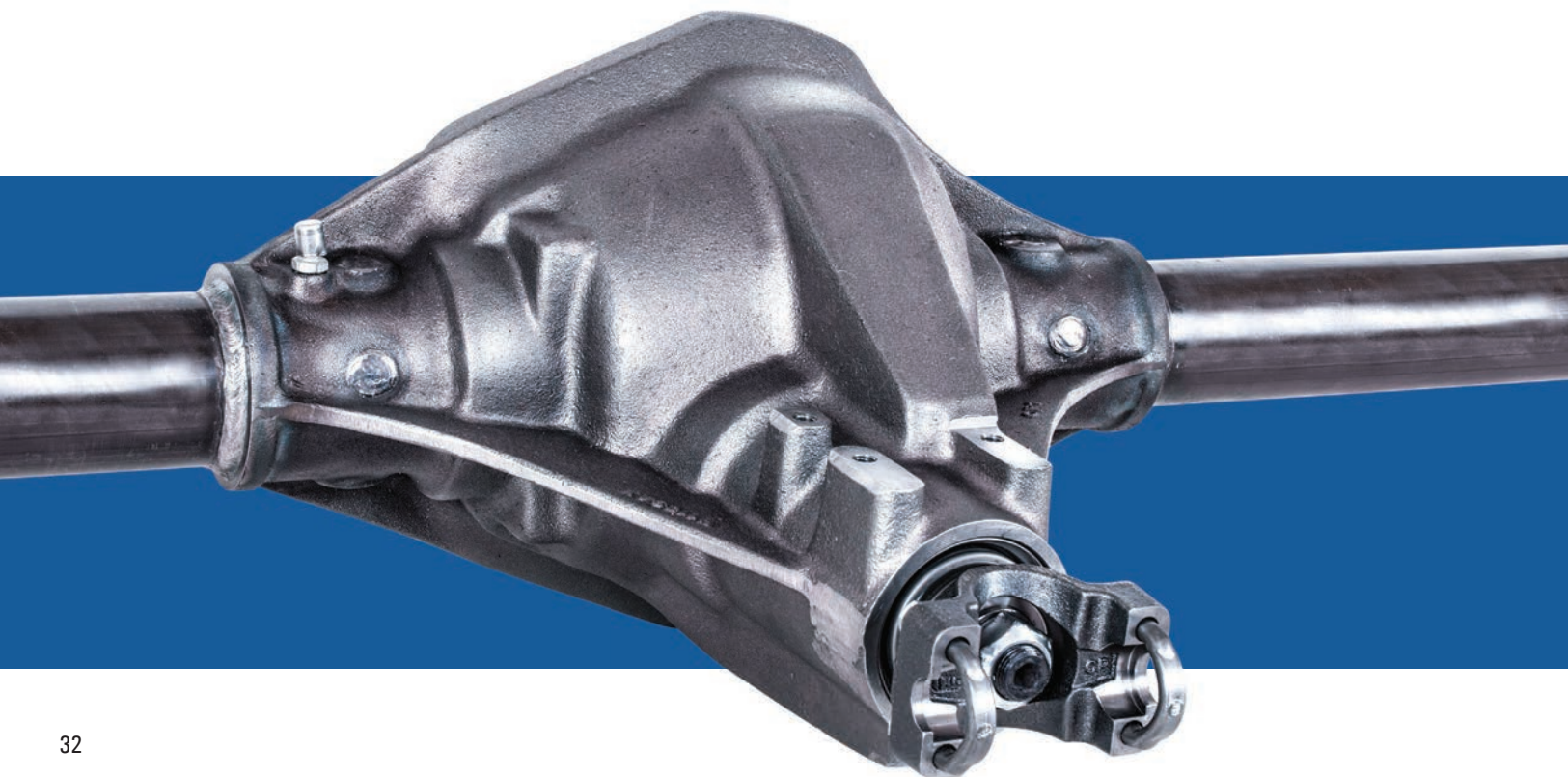



DRAG RACING: The S60 35 spline packages are equipped with a Pro Series lightweight steel spool, Standard gear set, 35 spline Pro Race axles, 1/2" wheel studs, HD 1350 series yoke, u-bolt kit, and steel rear cover. The 40 spline packages are supplied with a Pro Series lightweight steel spool, Standard gear set, 40 spline solid Pro Race axles, 5/8" stud kit, and steel rear cover. Standard gear ratio choices are 3.54, 3.73,

4.10, 4.30, 4.56, 4.88, 5.13, & 5.38. Pro gear are 4.10, 4.30, 4.56, 4.88, 5.38, & 6.17. Options include gun drilled 40-spline axles, pro gear set, chrome moly yoke, Strange aluminum black powder coated cover, LPW HD aluminum cover, and satin black powder coated housing. The steel cover would also be powder coated when this option is ordered.

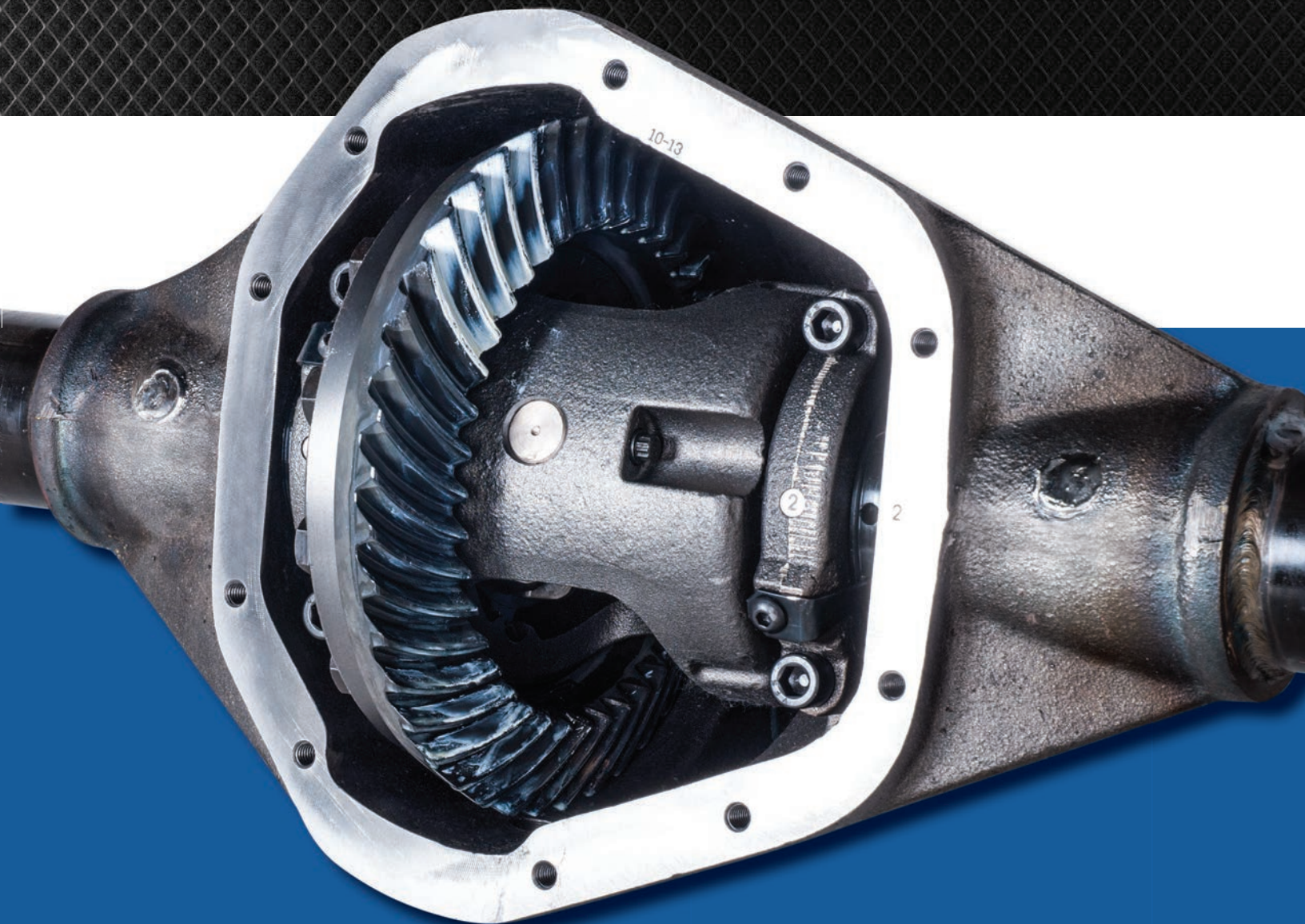

560 MOPAR

STREET/TRACK & DRAG RACE

MOPAR / LEAF SPRING / BARE (Custom widths are available at no additional charge)

PRSB05	Bare housing - no mounts / Spicer Trac-lock posi / 35 spline Alloy axles	\$2,166
PRSL05	Leaf spring housing / Spicer Trac-lock posi / 35 spline Alloy axles	\$2,286
Upgrades		
	OPRS01 From Trac-lock to Detroit locker	\$320
	OPRS02 From Trac-lock to Truetrack helical gear differential	\$320
	OPRS12 To 5/8" stud kit	\$60
Options		
	OPRS06 LPW HD aluminum cover	\$125
	OPRS08 Strange black powder coat aluminum cover	\$50
	OPRS18 Chrome moly pinion yoke	\$51
	H1199P-BLK Powder coat housing- satin black	\$159
Brakes		
	Late Big Ford 11" Drum brake kit installed	\$500
	Wilwood 11" Pro Street disc brake kit installed	\$624
	Wilwood 12" Pro Street disc brake kit installed	\$775

Brake kit prices include \$25 installation charge - See Brake Kit Section for More Brake Options

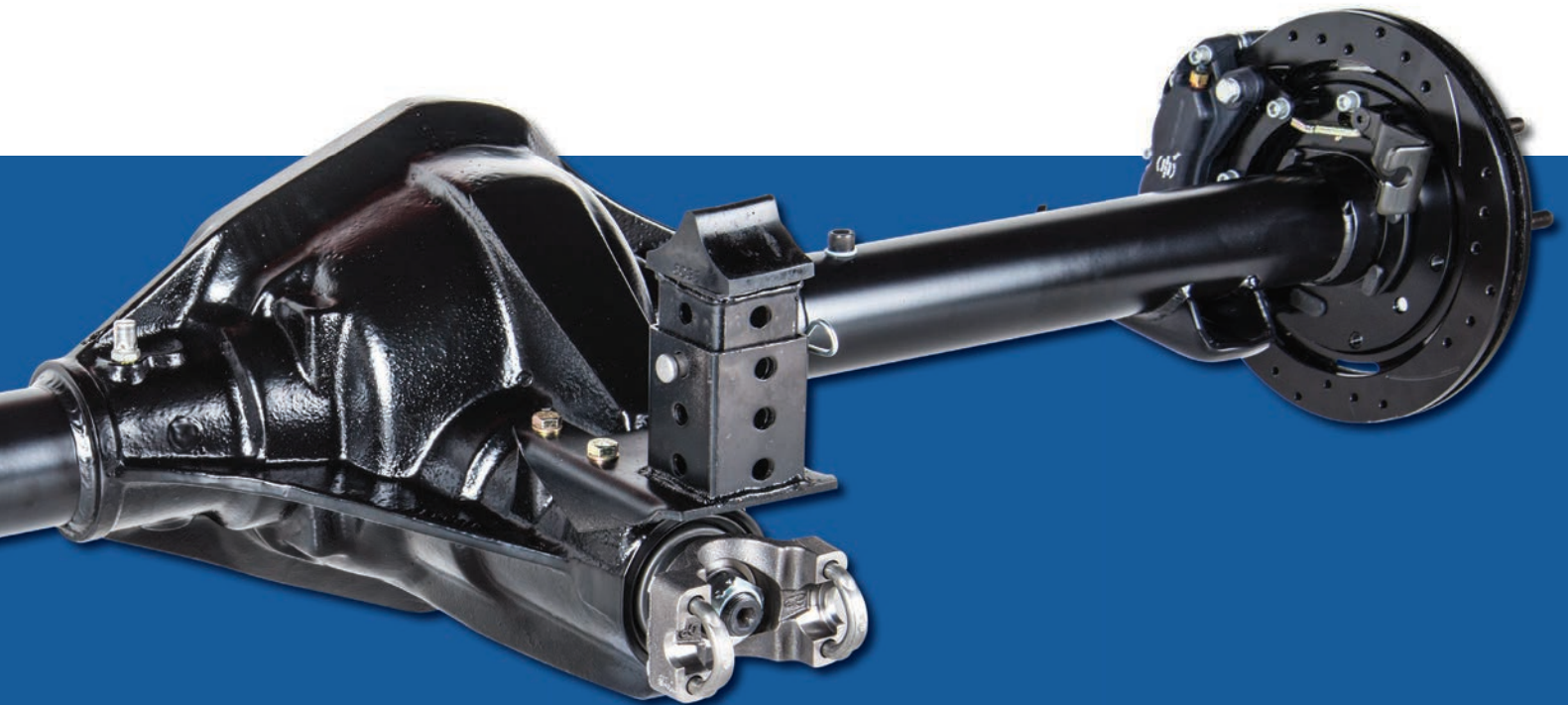

Mopar / Leaf spring / Bare (Custom widths are available at no additional charge)

PRSB10	Bare housing - no mounts / L/W spool / standard gear / 35 spline Pro axles	\$1,966
PRSL10	Leaf spring housing / L/W spool / standard gear / 35 spline Pro axles	\$2,086

Upgrades OPRS14 To 5/8" stud kit \$54

PRSB15	Bare housing - no mounts / L/W spool / standard gear / 40 spline solid Pro axles	\$2,260
PRSL15	Leaf spring housing / L/W spool / standard gear / 40 spline solid Pro axles	\$2,380

Upgrades OPRS16 To gun drilled 40 spline axles \$82

Options

OPRS22	Pro gear set	\$100
OPRS06	LPW HD aluminum cover	\$125
OPRS08	Strange black powder coat aluminum cover.....	\$50
OPRS18	Chrome moly pinion yoke	\$51
H1199P-BLK	Powder coat housing- satin black	\$159

Brakes

S-Series disc brake kit installed	\$494
Pro Race disc brake kit installed.....	\$624
Dual Pro Race disc kit installed	\$1,045
Sportsman Carbon disc brake installed	\$2,414

Brake kit prices include \$25 installation charge - See Brake Kit Section for More Brake Options



FLOATER KITS

PRO TOURING

Pro Touring Floater Kits: The Strange Pro Touring full floating kit design dramatically increases safety in comparison to a traditional flanged axle assembly. The floater spindle supports vehicle weight and resists cornering, braking, and accelerating loads, leaving the floater axle solely responsible for transmitting torque. A preload spacer between the tapered bearings bolsters maximum spindle nut torque eliminating bearing end play. Zero end play in the bearings eliminates piston knock-back encountered during hard cornering. Compact brake gap (3.50") clears most suspension components

located near original housing ends. The Strange Pro Touring floater kit features 2" O.D. chrome moly spindles, 35 spline drive plates, multiple patterns for 4 1/2", 4 3/4", and 5" bolt circles, and 1/2" x 20 press-in wheel studs. The floater axles and brake kit are sold separately. The axles are 35 spline to mate to the drive plate, and the inboard splines are made to match your specific carrier. The option for 5/8" x 18 press-in wheel studs also includes stud sleeves, lug nuts and washers. There are also options to adapt 2010 and earlier, or 2011 and later Mustang ABS systems.

F5010 Pro Touring floater kit- less axles and brakes \$1,100

Options

OPRS14	Replace 1/2" studs with 5/8" stud kit	\$54
ABSFM10	Adapt to accept 2005-2010 Mustang ABS sensor	\$20
ABSFM11	Adapt to accept 2011-2014 Mustang ABS sensor	\$50
A1040H24	Hy-Tuf solid 35 spline floater axle- 24" or less- each	\$143
A1040H28	Hy-Tuf solid 35 spline floater axle- 24 1/8" to 28"- each	\$154
A1040H32	Hy-Tuf solid 35 spline floater axle- 28 1/8" to 32"- each	\$165
A1040H36	Hy-Tuf solid 35 spline floater axle- 32 1/8" to 36"- each	\$176
B2712WC	Wilwood Pro Touring brake kit / 11" rotors / for 15" beadlock wheels / black calipers	\$895
B2711WC	Wilwood Pro Touring brake kit / 12.19" rotors / black calipers	\$895
B2711WCR	Wilwood Pro Touring brake kit / 12.19" rotors / red calipers	\$995
B2714WC	Wilwood Pro Touring brake kit / 14" rotors / black calipers	\$1,995
B2714WCR	Wilwood Pro Touring brake kit / 14" rotors / red calipers	\$2,095
N1948	Hub bearing- Inner and outer- each	\$13
N1949	Hub race- Inner and outer- each	\$10
F5056J	Hub seal- each	\$10
F5056W	Spindle nut wrench- Included in floater kit	\$45



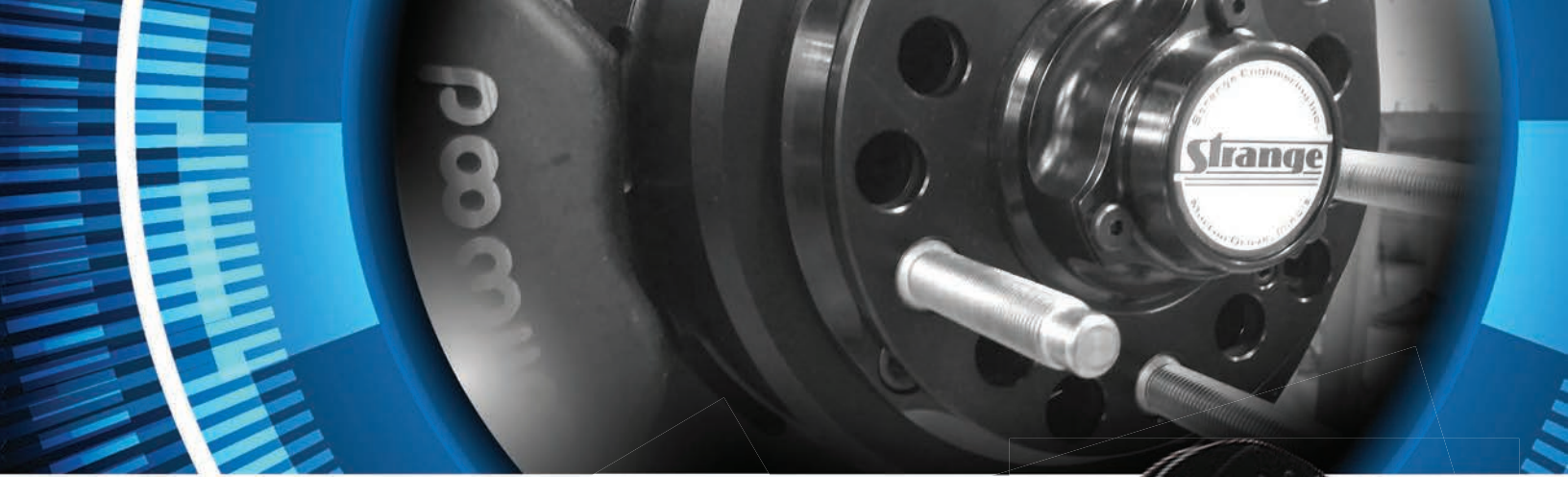

Compact brake gap
(3.50" clears most suspension
components located near
original housing ends

4 piston calipers



Internal Parking
Brake

2" O.D. Spindle

5/8"-18 or 1/2"-20 press-in wheel studs

4-1/2", 4-3/4 or 5" bolt circles

Rigid full floating design
dramatically increases safety
in comparison to a traditional
flanged axle assembly

Floater spindle supports vehicle weight
and resists cornering, braking, and
accelerating loads leaving the floater axle
solely responsible for transmitting torque

Preload spacer between the tapered
bearings bolsters maximum spindle nut
torque eliminating bearing end play

35 spline drive plate

Zero end play in the
bearings eliminates piston
knock-back encountered
during hard cornering

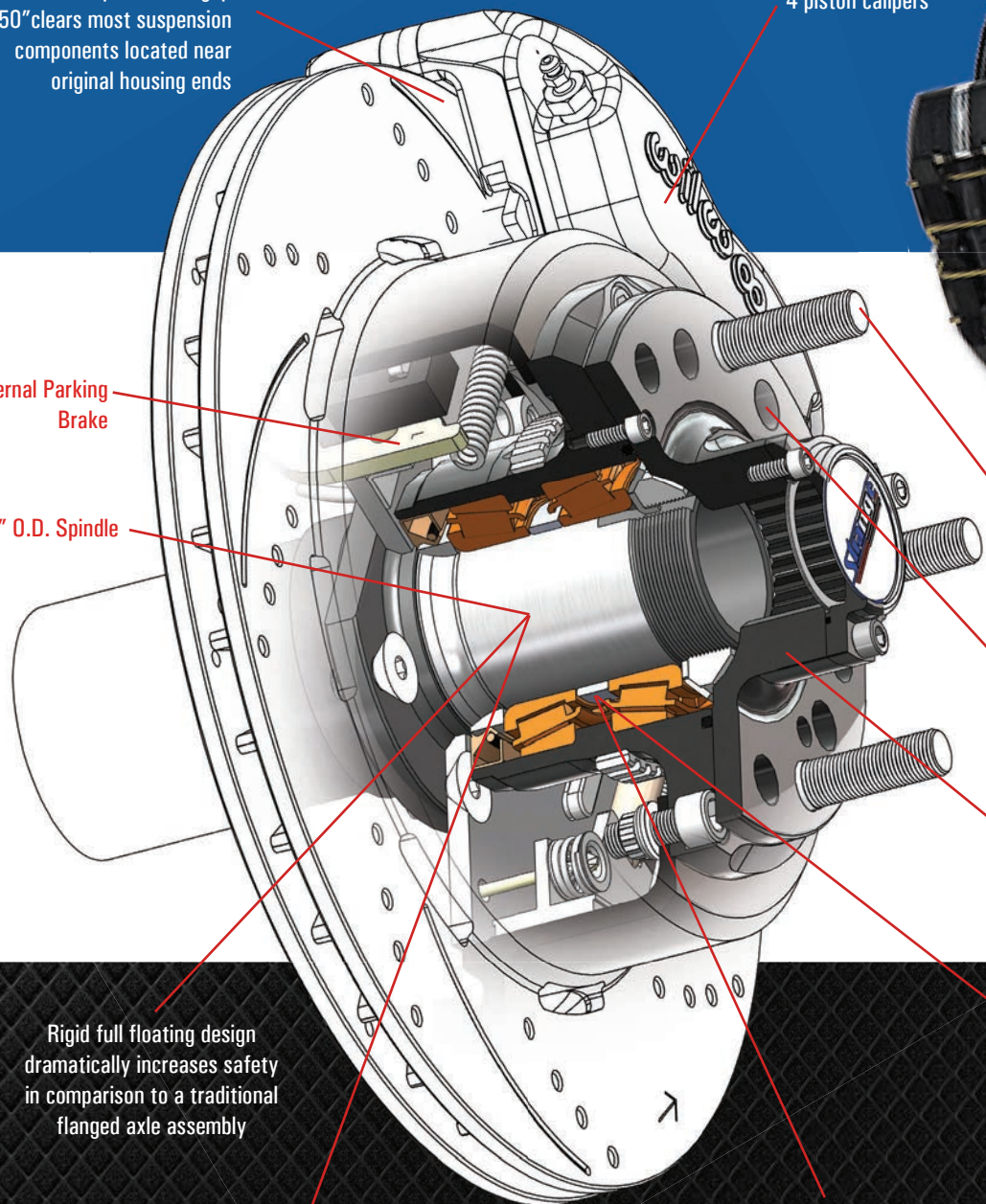

BRAKES

TECHNICAL

By use of friction, brakes convert kinetic energy into heat and dissipate it into the atmosphere. Kinetic energy is the amount of energy stored in a vehicle in motion. The basic factors that effect this are weight and speed. A heavy car takes more power to get up to the same speed as a lighter car, but will have a greater amount of stored energy. Therefore, it has to dissipate more heat to come to a stop. Speed has even a larger influence since it is squared in the calculation for kinetic energy. A vehicle traveling at 120 mph, has four times the stored energy than when it was doing 60 mph. What may appear to be a mild increase in mph, causes a much greater burden on the braking system.

MASTER CYLINDER SELECTION - PEDAL / HANDLE RATIO - PRESSURE: The 1.032" master cylinder is recommended for systems using single piston or two piston calipers up front, and four piston calipers in the rear. The 1.125" master cylinder is used with four piston calipers in both the front and rear. Brake pressure should always be checked with a brake pressure gauge before use. In disc brake applications used for drag racing only, front brake pressure should be 550 to 650 lbs and rear brake pressure 1,000 to 1,100 lbs. These pressures should be achieved with a lot of effort since they are at "lock-up" of the tires and the actual normal stopping pressures will be lower.

1.032" bore master cylinder: Pedal ratio- 5.5 to 1 / Handle ratio- 11 to 1

1.125" bore master cylinder: Pedal ratio- 6.5 to 1 / Handle ratio- 13 to 1

MOUNTING: The master cylinder, pedal / handle assembly, and calipers should be rigidly mounted. Movement or flex of the mounting location can cause inconsistent or spongy brake feel. Regardless of the pedal ratio, the master cylinder push rod needs to be parallel with the master cylinder while maximum brake pressure is achieved. This will promote even loading and wear on the piston providing the longest life possible. The bleeder screws should be the highest part of the caliper so that air can escape during bleeding. If this is not possible, the calipers can be rotated for bleeding then reinstalled. The brake calipers and pads need to be square to the rotors to promote even pad wear, consistent pedal feel, and eliminate brake drag. Most Strange 4-piston calipers have staggered piston diameters, therefore, they are directional and the arrow on the caliper must point in the direction of normal rotation of the rotor.

CALIPER SELECTION: Single piston front calipers are used for spindle mount wheels only. They should be used in vehicles weighing no more than 2,600 lbs that always deploy a parachute. Vehicles exceeding these limitations will experience poor pad life and will cause the rotors to overheat and warp. Two piston calipers are used in the front on vehicles with five lug wheels weighing up to 2,600 lbs. Four piston calipers are used in the front on vehicles with five lug wheels exceeding 2,600 lbs and in all rear applications.

PAD SELECTION: Soft metallic pads, used in all front applications, have excellent cold holding abilities with decent fade resistance. They are also used in rear applications where the vehicle does not exceed 150 mph in the 1/4 mile. The high heat and hard metallic pads are used in "rear only" applications exceeding 150 mph. High heat pads have a much higher threshold before brake fade than the soft metallic, but sacrifice starting line holding capability. The hard metallic have the same resistance to brake fade as the high heat, but offer better cold holding ability. They do tend to transfer additional pad material onto the brake rotor surface that has to be occasionally removed. On vehicles requiring the rear brakes to hold on the starting line under additional duress, such as loading torque converters or spooling turbochargers, the soft metallic pads would be a better choice due to their cold holding characteristics. Dual rear calipers would further enhance this capability.

PLUMBING: Braided stainless steel Teflon® lined hoses should be used only in flex applications, while 3/16" OD steel or stainless steel tubing should be used for the rest of the system. All lines should be firmly secured and isolated from vibration. All connections should be tight and NPT fittings sealed with Teflon® thread sealer. In applications where the master cylinder is mounted below the calipers, a 2 lb. residual pressure valve should be plumbed at the exit port(s) of the master cylinder. This keeps fluid from returning to the lowest point, the master cylinder, and pulling the caliper pistons back in their bores. If using a Strange master with drum brakes in the system, a 10 lb. residual valve must be installed in the line going to the drum brakes regardless of master cylinder location. When calipers or master cylinders are changed in an OEM system, the stock proportioning valve should be removed in favor of an adjustable proportioning valve. In most drag racing applications, it should be plumbed between the master cylinder and the front calipers to limit pressure. For street applications, or a system using disc front / drum rear, the proportioning valve would be plumbed between the master cylinder and the rear brakes. In either application, adjustments should be made to the valve in order to achieve the same braking threshold for front and rear brakes.

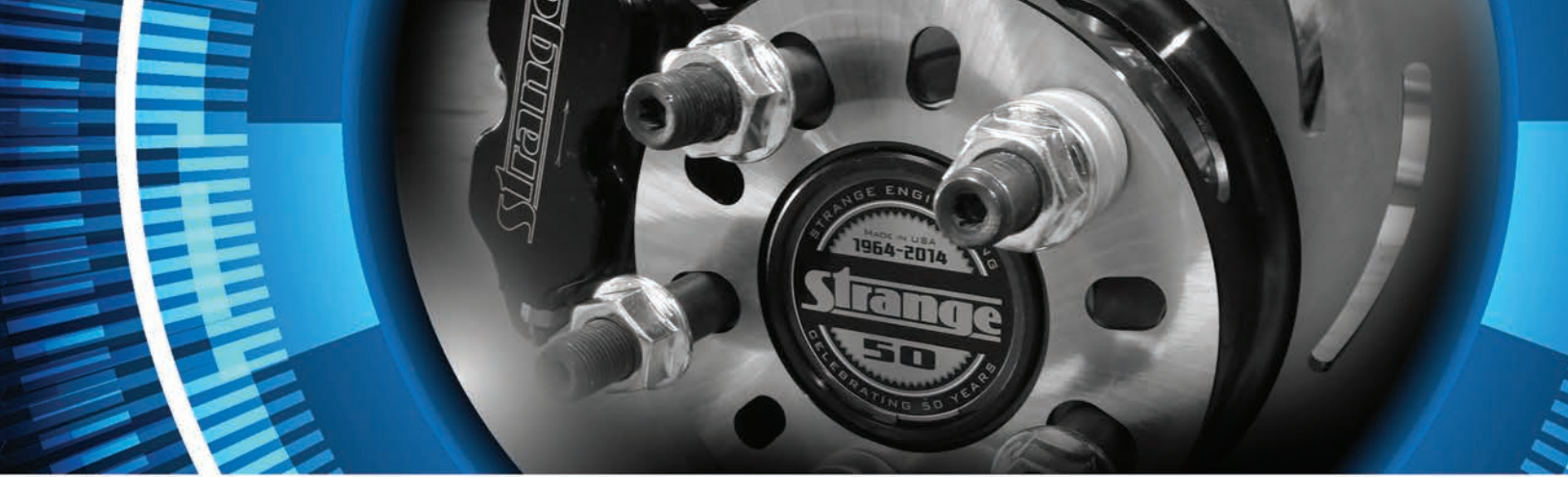

BRAKE FLUID: It is recommended to use DOT 4, DOT 5.1, or a high performance glycol based brake fluid for the braking temperatures experienced during drag racing. When changing to a different brake fluid, completely flush the system in order to experience the benefits of a higher temperature rated fluid. DOT 5 (Silicone based) brake fluid is not recommended for racing applications for several reasons. It does not mix with other fluids requiring a complete system rebuild, it is slightly compressible giving a soft pedal, and it does not absorb water. Since it will not absorb water, when moisture enters the system it settles to the lowest point which in most cases is the brake calipers. At braking temperatures moisture easily boils causing a loss or lack of pedal. Brake fluid should be changed at the beginning of each season to remove the absorbed water and any other contaminants.

	Advantages	Disadvantages	Boiling Point	
			Dry	Wet
DOT 3	Inexpensive / Absorbs water / Mixes with DOT 4 & 5.1	Lowest boiling point / Eats paint	400	285
DOT 4	Higher boiling point / Absorbs water / Mixes with DOT 3 & 5.1	Eats paint	445	310
DOT 5	High boiling point / Does not eat paint	Does not absorb water / Water settles and causes corrosion Difficult to bleed / Will not mix with DOT 3, 4, & 5.1	500	355
DOT 5.1	High boiling point / Absorbs water / Mixes with DOT 3 & 4	More expensive / Eats paint	527	365

BLEEDING: Fill the master cylinder reservoir with new DOT 4 or DOT 5.1 brake fluid. Start with the caliper furthest from the master cylinder and work your way to the caliper that is closest. Slide a clear plastic hose on the end of the bleeder screw. Open the bleeder screw approximately one turn and slowly depress and hold the brake pedal all the way down. Close the bleeder screw and release the brake pedal. Repeat this sequence until fluid comes out of the bleeder clear and free of air bubbles. Periodically check the fluid level in reservoir while bleeding and refill as necessary. After bleeding is complete, check entire system for leaks and the fluid level in the master cylinder.

BEDDING PROCEDURE: A bedding procedure is necessary to avoid premature brake fade, uneven pad deposits on the rotors, pad and rotor damage, and provide the best braking performance and the longest component life. It consists of 8-10 brake applications increasing in harshness while allowing the brakes to cool slightly in between; do not apply or drag the brakes between stops. After the last stop, the brakes should be allowed to cool completely. The concept is to slowly cycle the brakes up to operating temperature and back down avoiding thermal shock. A transfer of pad material to the rotor surface occurs that coats and protects the rotor, creating the actual wear surface. For best results, new pads should be bedded with seasoned rotors and new rotors should be bedded with seasoned pads.

COMMON ISSUES

BRAKE DRAG

- Master cylinder piston not fully retracting
- Calipers not square to rotors
- Tapered brake pad material
- Incorrect residual pressure valve
- Using drum brake master with disc brakes
- Using factory proportioning / combination valve
- Defective line-lock
- Contamination of brake fluid within the calipers

PULSING PEDAL

- Warped rotors
- Rotor faces not parallel
- Excessive play in wheel bearings
- Tire / wheel assembly out of balance

SOFT OR SPONGY PEDAL

- Pedal ratio too high
- Master cylinder bore too small
- Old brake fluid
- Air in system
- Deflecting caliper
- Caliper not square to rotor
- Too much flex line in system
- DOT 5 (Silicone) fluid in system

HARD PEDAL

- Pedal ratio too low
- Master cylinder bore too large
- Misalignment of master cylinder push-rod

STEEL BRAKE KITS

DRAG RACE ONLY

4-PISTON DIRECTIONAL CALIPER is standard in all front steel 4-piston, rear Pro Series, and Pro Series II brake kits that features an aluminum caliper in 1.750" and 1.625" piston bore sizes. Directional calipers allow pad loading and wear to be balanced against the natural changing temperatures across the pad face. Coupled with superior Strange caliper bridge-bolt strength, the dissimilar piston sizes allow for optimum braking, feel, and more consistent pad wear. The caliper also features anti-rattle clips and stainless steel pistons.

4-PISTON BILLET CALIPER is used in the new Strange Pro Series II Stainless brake kits. Similar to the caliper used in the Pro Carbon brake kits, it has the same superior bridge strength provided by the billet aluminum bodies. This brake caliper is designed for steel brakes and uses non-insulated pistons that are longer than normal providing additional stability. All four stainless steel pistons are 1.750" in diameter providing 7% greater clamping force in comparison to directional calipers.

4-PISTON BILLET LOW PROFILE CALIPER is an option in Strange Pro Series rear brake kits. Essential when using some of the newly designed 15" bead lock wheels, this caliper fits where no other can. Added ribs improve overall stiffness and drastically reduces deflection. Enhanced piston retraction reduces brake pad drag. Each caliper utilizes four individual brake pads to eliminate the problems experienced with warped backing plates. (Image shown below)

4-Piston Non-Directional Caliper is used in all S-Series rear brake kits that features an aluminum caliper with 1.750" piston bore sizes throughout. The S-Series caliper provides excellent bridge-bolt strength and increased clamping force. The caliper also features anti-rattle clips and stainless steel pistons.

DIRECTIONAL SLOTTED ROTORS are used in all brake kits except for the S-Series. The slots are precisely milled into the rotor surface to create a thermally stable braking surface with added benefits of reduced rotating weight and promoting braking consistency by eliminating pad glaze. The slots location, size, and shape were meticulously selected after field and dyno testing.

The slots provide a thermally stable rotor which vastly reduces distortion and/or warping of the rotor. Even though it would be far less expensive to offer only one slotted rotor, our testing clearly dictated the best slot design and placement required a rotational shaped slot; hence- directional rotors. The slot design also minimizes rotational weight. Unlike drilled rotors, the reduction in weight is achieved without sacrificing stability.



4-piston billet low profile caliper



Strange one piece solid and slotted rotors are both fully machined from premium forgings

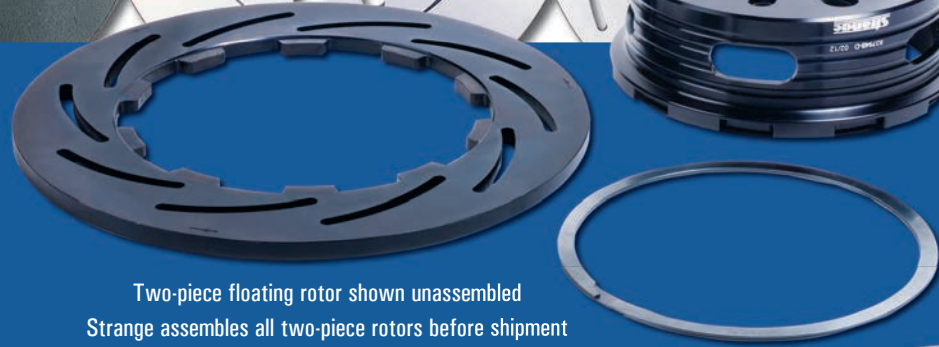

Two-piece floating rotor shown unassembled
Strange assembles all two-piece rotors before shipment

ONE PIECE ROTOR forging is used to produce all brake rotors except for Pro Series II. The one piece rotor is more expensive to manufacture when compared to the industries common 2 piece steel rotor design that uses bolts to hold it to an aluminum hat. Most two piece steel rotors are taken from inferior steel burn-outs and require additional assembly after purchasing. The one piece forged steel rotor offers several advantages when compared to bolt together two piece designs: (1) Due to the strength of our one piece forged steel rotor, a considerable amount of weight is eliminated in the steel hat area (slotted version). Aluminum hats are .250" to .500" thick and are not lightened in the side of the hat. The Strange rotor is only .125" thick in the mounting surface and has additional lightening holes on the side and top of the hat. In most cases, the slotted version rotor is lighter than bolt together two piece designs. (2) It eliminates mounting bolts that conduce binding and require constant torquing and/or cumbersome safety wire. (3) It provides superior dissipation of heat created by braking- due to one integral design (4) It accommodates several axle bolt circles (5) It can be re-surfaced to eliminate brake pad material build-up.



Two Piece Stainless Steel Rotor (Above)

TWO PIECE FLOATING ROTOR is standard in front and rear Pro Series II brake kits. The already successful 2 piece floating rotors have been further refined. Racers have depended upon the proven two piece design since 2008, including world champion Gary Stinnett. Through further R&D the 2012 version features a proprietary steel that has increased yield strength by 43%, tensile by 30% and significantly improved resistance to warping and creep at high temperatures. The floating rotor design allows for axial and radial growth of rotor as temperature increases, which greatly reduces warping and coning tendencies. In addition, the design eliminates bolts to attach the hat and rotor, which can become loose, require safety wire and require assembly. The rotor hat is fully machined from an aluminum forging which is strong, lightweight, and provides an ideal wheel mounting surface. The two-piece rotor, when compared to the already lightweight forged steel rotor, is .60 lbs lighter per corner (1.20 lbs per pair). The two piece rotor is ideal for weight reduction and abusive braking conditions.

TWO PIECE FLOATING (STAINLESS STEEL) ROTOR offers a new enhancement to the two piece floating rotor design. Stainless steel is typically known to be corrosion resistant, but it's main purpose here is the superior strength it provides at elevated temperatures. Thermal stress relieving further improves material stability resulting in high speed braking ability, without the concerns of warping or distortion. This rotor is included in the new Strange Pro Series II Stainless brake kits. It is compatible with soft, medium, and hard metallic pads.

Two-Piece hat (pictured right) - Fully machined from forged aluminum. The attention to detail is seen in the lightening grooves and pockets. The unique lug design permits axial and radial growth of the rotor



STEEL BRAKE KITS

DRAG RACE ONLY

S-SERIES REAR KIT is an economical alternative to the Pro Race brake kits. S-series rear drag race brake kits include: Forged aluminum 4-piston calipers with 1.75" diameter pistons, extra thick .430" solid forged rotors, billet caliper mounts, necessary mounting hardware and soft metallic pads. Optional pads are available at the same price. Use suffix "H" for high heat or "M" for hard metallic pads. (I.E. B6700WCH) The S-series brake kit weighs 29.10 lbs compared to 23.70 lbs for the Strange Pro Race brake kit. The Pro Race slotted rotor weighs 7.3 lbs, while the S-Series solid rotor weighs 10 lbs.



S-Series Brake Kit

Soft



B5010

High Heat



B5022

Hard

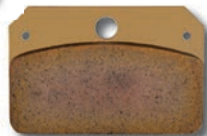

B5020

BRAKE PADS are offered in soft, high heat, and hard metallic compositions. Soft metallic, used in all front brake kits, are one of three pad options in rear kits. They have excellent starting line holding capabilities and, in rear applications, are best suited in vehicles traveling less than 150 mph. The high heat metallic pads are for rear only, have a much higher temperature rating, used in vehicles doing over 150 mph, but sacrifice on cold holding. Hard metallics have the same heat rating as the medium, but with better cold holding ability. The hard pads will transfer some additional pad material to the brake rotor surface which will eventually need to be removed when replacing the brake pads.



Billet aluminum caliper mounts - tailored to your application.



All Strange 4-piston and 2-piston Pro Race front brake kits feature a scalloped and drilled aluminum hub to ensure the greatest weight reduction



Pro Series II Brake Kit



Pro Series II Stainless Brake Kit

PRO SERIES II REAR BRAKE KIT with its two-piece floating rotor design, has been utilized by professional racers including world champion Gary Stinnett. The rotor and hat design allow for axial and radial growth of rotor as temperature increases, which greatly reduces warping and coning tendencies. In addition, it eliminates any bolts to attach the hat to the rotor which can become loose, require safety wire and additional labor. Pro Series II rear kits, when compared to the already lightweight Pro Series kit, is 1.20 lbs lighter. This kit features Strange 4-piston directional calipers (1.625" / 1.750" bores) with stainless steel pistons, caliper o-rings designed to minimize drag, billet aluminum caliper mounts, choice of brake pads (soft, high heat, or hard metallic) and mounting hardware. Dual calipers are optional. Brake kit weighs only 22.10 lbs with soft metallic pads. All brake pads materials are available in these rear kits.

PRO SERIES II (STAINLESS) REAR BRAKE KIT is an advancement in the two piece design by manufacturing the floating rotor out of stainless steel. While being corrosion resistant, the main benefit is the ability to survive under elevated temperatures without warping or distorting. The stainless steel is thermally stress relieved to further enhance material stability. The result, is a rotor that maintains superior strength at higher temperatures in comparison to carbon steel. Included are the new Strange billet calipers for steel brakes that share the same billet bodies as supplied in our Pro Series carbon brake kit. These calipers offer additional bridge strength and contain four longer and larger diameter (1.750") stainless steel pistons. This design provides more clamping force and piston stability. The result is the ability to quickly scrub off MPH in an index class and reduce the possibility of brake drag as the pads wear and pistons extend. Single or dual caliper kits are available with soft, high heat, or hard metallic brake pads. Add \$150 to any Pro Series rear brake kit for low profile caliper option.

PRO SERIES REAR KIT features Strange forged steel one piece rotor, which is far superior to common bolt together two piece rotors in weight reduction, strength and longevity. All Strange Pro Race rotors are slotted. Slotting was developed by Strange to minimize warpage, while maximizing weight reduction. Every kit features the sought after Strange 4-piston directional calipers. The directional calipers accomplish superior bridge bolt strength at only 2.70 pounds. Strange directional calipers feature 1.750" and 1.625" OD stainless steel pistons to assure optimal pad wear and exceptional pedal / handle feel. Every Strange caliper is internally ported and is designed to assist piston retraction. Brake kit weighs only 23.70 lbs with soft metallic pads. All brake pads materials are available in these rear kits.



Pro Series Dual Caliper Brake Kit

STEEL FRONT BRAKE KITS

DRAG RACE ONLY



B4110WC pictured above - is a typical 4-piston front brake kit; however, kits vary per application

Strange Heavy Duty Front Brake Kits

Strange Heavy Duty front brake kits offer a tremendous weight savings over OEM brake components. The entire Pro Series 4-piston brake kit, with forged slotted rotors, weighs only 33.50 lbs. The Pro Series II, featuring 2 piece floating rotors, weighs 32.50 lbs. Both kit weights include bearings, hubs, rotors, pads, calipers, pads, etc... Strange Engineering's brake kits are unsurpassed in detail. One example of our unparalleled attention to detail is evident in our hub design. Each hub has one bolt circle. Instead of adding an additional bolt circle, the hub is scalloped and lightening holes are milled to reduce rotating weight. The hub cap is fully machined and hollowed out to maximize weight reduction. We feel that the extra effort into weight reduction is expected from customers who want a premium quality Drag Racing brake kit.

Typical Heavy Duty front kits Include: Strange 4-piston billet directional calipers, soft metallic pads, forged slotted steel rotors, scalloped aluminum hubs with Timken® bearings and races, seals, studs, billet aluminum mounts, and necessary mounting hardware.



STEEL FRONT BRAKE KITS

DRAG RACE ONLY

APPLICATIONS

MAKE	MODEL	YEAR	OEM	PART#	TYPE	BOLT CIRCLE	PRICE	NOTES
DODGE	CORONET	66-69	DRUM	B4158WC	HEAVY DUTY	4 1/2"	\$795	
		70-72	DISC	B4159WC	HEAVY DUTY	4 1/2"	\$795	
	CHALLENGER	70-72	DRUM	B4158WC	HEAVY DUTY	4 1/2"	\$795	FOR 10" DRUM SPINDLES
		70-72	DISC	B4159WC	HEAVY DUTY	4 1/2"	\$795	
		73-74	DISC	B4160WC	HEAVY DUTY	4 1/2"	\$795	
		09-12	DISC	B4184WC	HEAVY DUTY	4 1/2"	\$895	
	CHARGER	66-69	DRUM	B4158WC	HEAVY DUTY	4 1/2"	\$795	
		70-72	DISC	B4159WC	HEAVY DUTY	4 1/2"	\$795	
	DART	63-72	DRUM	B4156WC	HEAVY DUTY	4 1/2"	\$795	FOR 9" DRUM SPINDLES
		65-72	DRUM	B4162WC	HEAVY DUTY	4 1/2"	\$795	FOR 10" DRUM SPINDLES
		73-76	DISC	B4160WC	HEAVY DUTY	4 1/2"	\$795	
	DUSTER	65-72	DRUM	B4162WC	HEAVY DUTY	4 1/2"	\$795	FOR 10" DRUM SPINDLES
	LANCER	61-62	DRUM	B4156WC	HEAVY DUTY	4 1/2"	\$795	FOR 9" DRUM SPINDLES
	ROAD RUNNER	70-72	DISC	B4159WC	HEAVY DUTY	4 1/2"	\$795	
	R/T	67-69	DRUM	B4158WC	HEAVY DUTY	4 1/2"	\$795	
	SATELLITE	70-72	DISC	B4159WC	HEAVY DUTY	4 1/2"	\$795	
	SUPER BEE	68-69	DRUM	B4158WC	HEAVY DUTY	4 1/2"	\$795	
		70	DISC	B4159WC	HEAVY DUTY	4 1/2"	\$795	
PLYMOUTH	BARRACUDA	64-69	DRUM	B4156WC	HEAVY DUTY	4 1/2"	\$795	FOR 9" DRUM SPINDLES
		65-69	DRUM	B4162WC	HEAVY DUTY	4 1/2"	\$795	FOR 10" DRUM SPINDLES
		70-72	DRUM	B4158WC	HEAVY DUTY	4 1/2"	\$795	FOR 10" DRUM SPINDLES
		70-72	DISC	B4159WC	HEAVY DUTY	4 1/2"	\$795	
		73-74	DISC	B4160WC	HEAVY DUTY	4 1/2"	\$795	
	BELVEDERE	66-69	DRUM	B4158WC	HEAVY DUTY	4 1/2"	\$795	
		70	DISC	B4159WC	HEAVY DUTY	4 1/2"	\$795	
	GTX	67-69	DRUM	B4158WC	HEAVY DUTY	4 1/2"	\$795	
		70-71	DISC	B4159WC	HEAVY DUTY	4 1/2"	\$795	
	PLYMOUTH	62-64	DRUM	B4158WC	HEAVY DUTY	4 1/2"	\$795	
	ROAD RUNNER	68-69	DRUM	B4158WC	HEAVY DUTY	4 1/2"	\$795	
		70-72	DISC	B4159WC	HEAVY DUTY	4 1/2"	\$795	
	VALIANT	60-72	DRUM	B4156WC	HEAVY DUTY	4 1/2"	\$795	FOR 9" DRUM SPINDLES
		65-72	DRUM	B4162WC	HEAVY DUTY	4 1/2"	\$795	FOR 10" DRUM SPINDLES
		73-76	DISC	B4160WC	HEAVY DUTY	4 1/2"	\$795	

To order brake kit with two piece rotors- Include "2" at the end of the part number (i.e. B4110WC2)
Add \$100 to prices shown for medium and heavy duty kits and \$150 for lightweight kits

* SEE INSTRUCTION SHEET FOR DETAILS ON MODIFICATIONS www.strangeeng.net

STEEL REAR BRAKE KITS

DRAG RACE ONLY

Brake kit part numbers listed below include soft metallic pads. Add suffix "H" for high heat metallic pads or "M" for hard metallic pads. For example: B1700WCH / B1700WCM. Choice of pads will not increase price.

Pro Series II Kits, with two-piece floating rotors, are available for all rear kits except Small Ford. For a Pro Series II kit, add "2" to the end of the part number. For example: B1700WC2 / B1700WCH2 / B1700WCM2 / B1700WCD2 / B1700WCDH2 / B1700WCDM2. The price will increase \$100 over the price shown.

Pro Series II Stainless Kits, with two piece stainless steel rotors and billet calipers, are available for Symmetrical and Olds ends. Add "2S" after the part number for these kits. For example: B1700WC2S / B1700WCH2S / B1700WCM2S / B1700WCD2S / B1700WCDH2S / B1700WCDM2S. The price will increase \$400 over the price shown.

Add \$150 to any Pro Series rear brake kit for low profile caliper option.

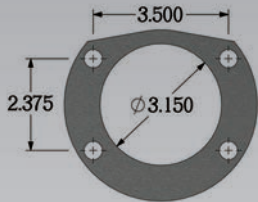

FORD (EARLY BIG FORD)

- B1707WC** Pro Series rear steel brake kit For Early Big Ford housing ends - F= 2.500"... **\$595**
- B1707WCD** Pro Series rear steel **DUAL** caliper brake kit For Early Big Ford housing ends - F= 2.500"... **\$1,020**
- B1708WC** Pro Series rear steel brake kit For Early Big Ford housing ends - F= 2.3325"... **\$595**
- B1708WCD** Pro Series rear steel **DUAL** caliper brake kit For Early Big Ford housing ends - F= 2.3325"... **\$1,020**
- B6707WC** S-Series (non-slotted rotor) rear steel brake kit For Early Big Ford housing ends - F= 2.500"... **\$469**
- B6708WC** S-Series (non-slotted rotor) rear steel brake kit For Early Big Ford housing ends - F= 2.3325"... **\$469**

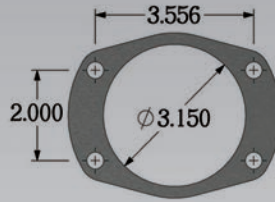

FORD (LATE BIG FORD)

- B1706WC** Pro Series rear steel brake kit For Late Big Ford housing ends - F= 2.500"... **\$595**
- B1706WCD** Pro Series rear steel **DUAL** caliper brake kit For Late Big Ford housing ends - F= 2.500"... **\$1,020**
- B6706WC** S-Series (non-slotted rotor) rear steel brake kit For Late Big Ford housing ends - F= 2.500"... **\$469**

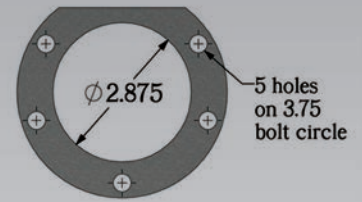

MOPAR

- B1704WC** Pro Series rear steel brake kit For 65-73 Mopar housing ends. Includes A1022 axle bearings - F= 2.663"... **\$635**
- B1704WCD** Pro Series rear steel **DUAL** caliper brake kit For 65-73 Mopar housing ends - Includes A1022 axle bearings - F= 2.663"... **\$1,020**
- B6704WC** S-Series (non-slotted rotor) rear steel brake kit For 65-73 Mopar housing ends - Includes A1022 axle bearings - F= 2.663"... **\$509**

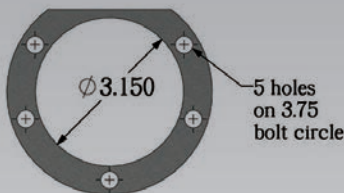

MOPAR (STRANGE 3.150")

- B1705WC** Pro Series rear steel brake kit For Strange H1147 Mopar patterned housing ends F= 2.500"... **\$595**

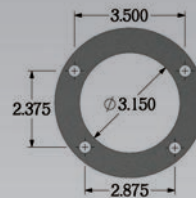

OLDS

- B1700WC** Pro Series rear steel brake kit For 57-64 Olds housing ends - F= 2.832"... **\$595**
- B1700WCD** Pro Series rear steel **DUAL** caliper brake kit For 57-64 Olds housing ends - F= 2.832"... **\$1,020**
- B6700WC** S-Series (non-slotted rotor) rear steel brake kit For 57-64 Olds housing ends - F= 2.832"... **\$469**

STEEL REAR BRAKE KITS

CALIPER KITS

STRANGE 4-PISTON CALIPER KITS

Strange 4-piston directional caliper provides superior strength at only 2.70 lbs. The 1.750" and 1.625" OD stainless steel pistons assure optimal pad wear.

Strange 4-piston **Billet** non-directional caliper further increases bridge strength providing a firmer pedal feel. All four stainless steel pistons are 1.750" and are longer which creates 7% more clamping force and provides more piston stability.

Strange Low Profile billet calipers are designed with the maximum wheel clearance available. Essential when using some of the latest 15" bead lock wheels, this caliper fits where others don't. Ribs are added to increase stiffness and piston design improves retraction reducing brake drag. Each caliper uses 4 independent pads that eliminate backing plate warpage and the associated problems.

Strange S-Series non-directional caliper is equipped with 1.750" OD stainless steel pistons and are designed to fit .430" thick S-Series rotor.

- B1850 Directional 4 piston calipers with soft metallic pads & hardware- kit..... \$369
- B1853 Directional 4 piston calipers with high heat metallic pads & hardware- kit..... \$369
- B1855 Directional 4 piston calipers with hard metallic pads & hardware- kit..... \$369 (shown next page)
- B1850LP Billet low profile calipers with soft metallic pads & hardware kit..... \$569
- B1853LP Billet low profile calipers with high heat metallic pads & hardware kit..... \$569
- B1855LP Billet low profile calipers with hard metallic pads & hardware kit..... \$569
- B1950 Billet 4 piston calipers with soft metallic pads & hardware- kit..... \$429

- B1953 Billet 4 piston calipers with high heat metallic pads & hardware- kit \$429
- B1955 Billet 4 piston calipers with hard metallic pads & hardware- kit \$429
- B6850 S-Series 4 piston non-directional calipers with soft metallic pads & hardware- kit \$323
- B6853 S-Series 4 piston non-directional calipers with high heat metallic pads & hardware- kit ... \$323
- B6855 S-Series 4 piston non-directional calipers with hard metallic pads & hardware- kit \$323

Caliper mounting bolt holes are on 5.250" centers on all above kits



STEEL REAR BRAKE KITS

COMPONENTS



STRANGE REPLACEMENT ROTORS

B2790	11.250" non-slotted .430" thick rotor for S-Series rear brakes	\$95	B2794RS	11.250" slotted stainless steel rotor for Pro Series II two piece rear brakes- RH	\$295
B2792	11.250" slotted rotor for Pro Series rear brakes- RH	\$137	B2794LS	11.250" slotted stainless steel rotor for Pro Series II two piece rear brakes- LH	\$295
B2793	11.250" slotted rotor for Pro Series rear brakes- LH	\$137	B2795	11.250" tapered slotted rotor for MD and HD front brake kits- RH	\$137
B2794R	11.250" slotted rotor for Pro Series II two piece rear brakes- RH	\$195	B2796	11.250" tapered slotted rotor for MD and HD front brake kits- LH	\$137
B2794L	11.250" slotted rotor for Pro Series II two piece rear brakes- LH	\$195			

CALIPERS, PADS, & REBUILD KITS



B3341 for most non-Strange single piston calipers. Specify brand & pad OD.



B4010 / B4020 / B4022 Strange four piston low profile caliper



B2510 Strange single piston & two piston caliper



B3330 Kelsey-Hayes 1200



B3325 / B3326 Wilwood & JFZ four piston cotter pin caliper



B5010 / B5020 / B5022 Strange four piston caliper

B5001 Strange S-Series 4-piston (non-directional) caliper 5.250" bolt centers ... \$139

B5002 Strange Pro Series 4-piston directional caliper 5.250" bolt centers - RH side ... \$159

B5004 Strange Pro Series 4-piston directional caliper 5.250" bolt centers - LH side ... \$159

B1900 Strange Pro Series 4-piston **Billet** caliper 5.250" bolt centers ... \$189

B5010 Pad for Strange 4-piston caliper Soft metallic ... \$17

B5022 Pad for Strange 4-piston caliper High Heat metallic \$17

B5020 Pad for Strange 4-piston caliper Hard metallic \$17

B5109 O-ring kit for Strange Pro Series 4-piston caliper Directional- 1.625" / 1.750" bores ... \$9

B5109R O-ring kit for Strange Pro Series 4-piston caliper Directional- Low Drag conversion ... \$9

B5106 O-ring kit for Strange S-Series 4-piston caliper Non-directional- 1.750" bores ... \$9

B5106R O-ring kit for Strange S-Series 4-piston caliper Non-directional- Low Drag conversion ... \$9

B5105 O-ring kit for early Strange 4-piston caliper Various o-rings for all versions- Pre 96 ... \$11

Rebuild kits service one caliper
Brake pads are sold as each

B3341 Pad for Airheart 175H, Kelsey-Hayes 400 / 500 & Wilwood 120-1064 caliper ... \$8

B4010 Pad for Strange low profile four piston caliper - Soft Metallic ... \$15

B4020 Pad for Strange low profile four piston caliper - Hard Metallic ... \$15

B4022 Pad for Strange low profile four piston caliper - High Heat Metallic \$15

B3325 Pad for Wilwood / JFZ 4-piston caliper Soft metallic- Cotter pin retention ... \$17

B3326 Pad for Wilwood / JFZ 4-piston caliper Hard metallic- Cotter pin retention ... \$17

B3330 Pad for Kelsey-Hayes 1200 caliper Hard metallic ... \$20

Rebuild kits service one caliper
Brake pads are sold as each



Strange Billet Caliper
B1900

BRAKES

MASTER CYLINDERS, VALVES, BRAKE GAUGE, & BRAKE FITTINGS

The Strange dual in-line master cylinder is ideal for sportsman classes requiring four wheel braking. The 1.032" bore master cylinder should be used if single piston or 2-piston calipers are used for the front and 4-piston on the rear. The 1.125" bore master cylinder will allow optimum volume and pressure for vehicles using 4-piston calipers front and rear.

- Strange aluminum body • Includes hard-line fittings
- Economical • Holes provided for side mount application
- Both front and rear outlets are tapped 1/2-20

B3359	1.125" bore master cylinder with mounting hardware	\$99
B3359TA	1.125" bore master cylinder without mounting hardware....	\$85
B3360	1.032" bore master cylinder with mounting hardware.....	\$99
B3360TA	1.032" bore master cylinder without mounting hardware...	\$85

The B-3369 can replace an OEM non-adjustable proportioning valve, or used in new vehicle construction. Any brake system needs to be properly proportioned to effectively stop a vehicle. Drag race applications commonly have a much greater tire contact area on the rear tire in comparison to the front. The adjustable proportioning valve is installed into the front brake line, reducing front pressure until the desired front to rear bias is achieved. Street vehicles typically install the valve into the rear brake line, allowing reduction in rear brake pressure. A brake pressure gauge, such as the P2360, should be used to check pressures front and rear before the vehicle is driven. The adjustable proportioning valve will not increase line pressure, it can only reduce. The B-3369 is threaded 1/8" NPT.

B3369 Adjustable proportioning valve ... \$49



EXTERNAL RESIDUAL PRESSURE VALVES are used when the master cylinder is mounted at or below the level of the calipers or when drum brakes are used. If not, a long pedal travel and poor braking can occur. The valve maintains a low pressure of fluid between the valve and the brake caliper or wheel cylinder. This keeps the pads or shoes ready to move as soon as the pedal is depressed. Drum brakes need a 10 lbs valve to keep the wheel cylinder cups expanded. Disc brake applications require a 2 lbs valve only when the master cylinder is mounted at or below the level of the calipers. External residual valves are best installed as close as possible to the master cylinder. Each valve is manufactured from billet aluminum and is tapped 1/8" NPT on both ends.

B3366 2 lbs external pressure valve ... \$22

B3367 10 lbs external pressure valve ... \$22

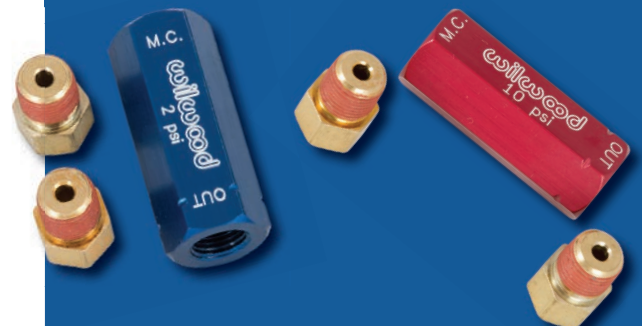



The P2360 GAUGE accurately measures brake line pressure. Without proper brake pressure, even quality braking systems can be rendered significantly less effective. This gauge verifies pressure and is essential for trouble shooting brake system problems. The Strange pressure gauge makes it easier to determine appropriate changes in pedal ratio or to select the proper master cylinder bore size. Each gauge is shipped with a bleeder adapter for further convenience.













P2360 Brake pressure gauge & adapter ... \$32



BRAKE FITTINGS

- P2316 3 AN x .125" NPT adapter \$2
- P2318 3 AN coupling nut \$1
- P2319 3 AN coupling nut sleeve \$1
- P2322 3 AN x .125" NPT 90° adapter ... \$5
- P2323 3 AN x .125" NPT 45° adapter ... \$8
- P2332 3 AN bulkhead union \$5
- P2333 3 AN bulkhead tee on branch \$15
- P2334 3 AN bulkhead tee on run \$15

- P2335 Nut for 3 AN bulkhead fitting \$1
- P2336 3 AN x .125" NPT tee on run \$13
- P2337 3 AN bulkhead 90° elbow \$15

 P-2300	 P-2322	 P-2334	 P-2355
 P-2316	 P-2332	 P-2337	 P-2356
 P-2319	 P-2333	 P-2336	 P-2357

- P2339 Weld-on bracket for bulkhead fitting- For round tubing \$3
- P2356 3 AN x 1/2-20 adapter for Strange B3360 / B3359 \$9
- P2357 3 AN x 9/16-20 master cylinder adapter \$9

BRAKES

BRAKE LINE & REAR BRAKE KITS



- P2338** 3/16" steel brake line- 25 ft roll ... \$31
- P2340** 16" braided stainless flex line with 3 AN straight / 90° ends ... \$18
- P2341** 18" braided stainless flex line with 3 AN straight ends \$21
- P2342** 20" braided stainless flex line with 3 AN straight ends \$21
- P2343** 22" braided stainless flex line with 3 AN straight ends \$21
- P2344** 24" braided stainless flex line with 3 AN straight ends \$21
- P2382** Dragster 3 AN fitting & hose kit for plumbing from calipers to master cylinder- Hard line not included \$92
- P2383** Front door car 3 AN fitting & hose kit for plumbing from calipers to line lock- Hard line not included \$88
- P2384** Rear door car 3 AN fitting & hose kit for plumbing from calipers to master cylinder- Hard line not included ... \$83



STREET AND STREET/TRACK BRAKE KITS

Brake components designed for Street / Track vehicles must be able to endure the elevated heat conditions that exist under constant use. Drum brakes are fine for many street cars, but do not offer sufficient heat dissipation for track use. In a drum brake assembly, the braking surface, shoes, and wheel cylinder are all enclosed limiting heat dissipation. A disc system has everything exposed to the surrounding air providing a more efficient braking system. When changing brakes, it is important to look at the master cylinder, pedal assembly, proportioning valve, and brake lines. What has worked well with the OEM brakes, may now be completely wrong for the new brake system.

WILWOOD REAR DISC BRAKE KITS

The Wilwood rear disc brake kits are an excellent value and ideal for street and street/track vehicles. These kits include rotors, calipers, internal parking brakes, mounting brackets, and attaching hardware. The rotors are for 5 lug wheels, and have 4 1/2", 4 3/4", and 5" bolt circles for use with 1/2" wheel studs. Rotors can have one bolt pattern modified for 5/8" studs for an additional \$15. Caliper mounting brackets fit the Late Big Ford housing end (Strange H1137). These kits are designed for a 2.50" brake offset ("F" dimension), 3.060" brake register ("A" dimension), axle flange OD of 6.61" or less ("D" dimension), and require a 1.00" access hole on a 4.50" BC. The 11" Low Profile kit will fit some 14" wheels (minimum inside diameter of 13.14") and all 15" or larger. The 12.190" will fit some 15" wheels (minimum inside diameter of 14.2") and larger. The brake hoses and parking cables are not included.



B2708WC Wilwood 12.19" brake kit with parking brake for Late Big Ford ends - H1137
A=3.060" - F=2.500" - 4 1/2" & 4 3/4" for 1/2" studs ... \$750

B2707WC * Wilwood 12.19" brake kit with parking brake for Late Big Ford ends - H1137
A=3.060" - F=2.500" - 4 1/2" & 4 3/4" for 1/2" studs ... \$750

B2709WC Wilwood 11" Low Profile brake kit with parking brake for Late Big Ford ends - H1137
A=3.060" - F=2.500" - 4 1/2" & 4 3/4" for 1/2" studs ... \$599

B2710WC * Wilwood 11" Low Profile brake kit with parking brake for Late Big Ford ends - H1137
A=3.060" - F=2.500" - 4 1/2" & 4 3/4" for 1/2" studs ... \$599

* For staggered rear shocks - One caliper mounts forward and one rearward

All kits supplied with black calipers - Other colors available at an additional charge

Rotors can be drilled for 5/8" studs in one bolt circle for \$15 pair

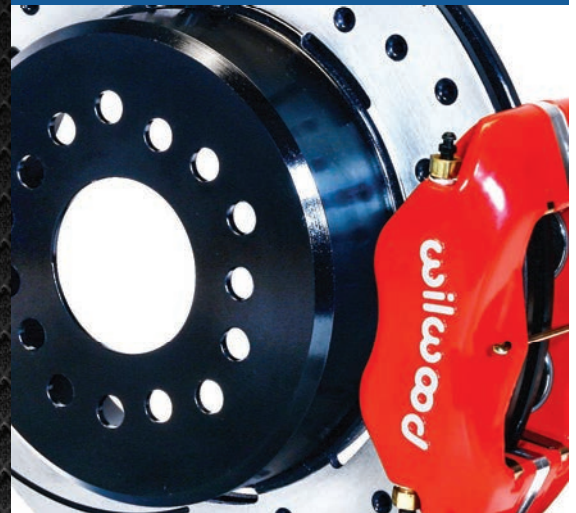

DRUM BRAKE KITS

Both 11" drum brake kits fit a brake register size of 2.780" ("A" dimension). Drums are drilled to accept 1/2" wheel studs and have 5 lug 4 1/2" & 4 3/4" bolt circles. They can be drilled for an additional bolt circle or machined to accept 5/8" studs for an additional \$15⁰⁰. The B1606 kit fits the Late Big Ford housing end, Strange H1137, with a brake offset of 2.50" ("F" dimension). The B1608 fits the Early Big Ford housing end, Strange H1135, with a brake offset of 2.332" ("F" dimension). The brake hoses and parking cables are not included.

B1606 Drum brake kit for Late Big Ford ends - H1137
A=2.780" - F=2.500" - 4 1/2" & 4 3/4" for 1/2" studs \$475

B1608 Drum brake kit for Early Big Ford ends - H1135
A=2.780" - F=2.332" - 4 1/2" & 4 3/4" for 1/2" studs \$575

B1600D Drill B1606 or B1608 for different bolt circle or stud size ... \$15



SHOCKS

STREET/TRACK ALUMINUM BOLT-IN

STREET / TRACK ALUMINUM BOLT-IN SHOCKS

Strange aluminum bolt-in shocks were developed with the help of several Sportsman racers, street / track competitors, and muscle car enthusiasts. This collaboration led to the creation of a shock that is very responsive, consistent, and can be easily tailored to various conditions. The Strange shock body and eyelets are fully machined from high-grade aluminum, carefully assembled, and fully inspected. In-house dynamometer testing enables us to completely analyze shocks at all shaft speeds. This allows us to continue our valve development and stay ahead of the performance shock industry. Although Strange shocks offer a wide range of adjustment, re-valving is available to suit your specific requirements.

- Lightweight Aluminum Bolt-In Shocks
- Easily Accessible External Adjustment
- Extension Tuning Knob - Single & Double Adjustable
- Compression Tuning Knob - Double Adjustable
- Billet Steel Cross Bars & Polyurethane Bushings
- Wide Range of Adjustments are Ideal for Street & Track

STRANGE ALUMINUM BOLT-IN SINGLE ADJUSTABLE

Shocks give the customer ability to control the dampening effect of the shocks extension resistance. Whether you are adjusting the ride of your street machine, handling of a Pro Touring, or tuning a drag race vehicle, Strange shocks are a valuable tool to alter the response of your suspension to various conditions you may encounter. Shock extension (rebound) is easily adjusted by turning a conveniently located external knob. The external knob offers 10 precise settings and allows for a wide range of adjustment.

STRANGE ALUMINUM BOLT-IN DOUBLE ADJUSTABLE:

Shocks are offered to those seeking the ultimate in suspension tuning. The double adjustable shock offers all the benefits of the single adjustable shock, but also incorporates an additional knob for accurately adjusting compression (bump). The ability to independently adjust both extension and compression allows the chassis tuner complete dampening control of the vehicles suspension.

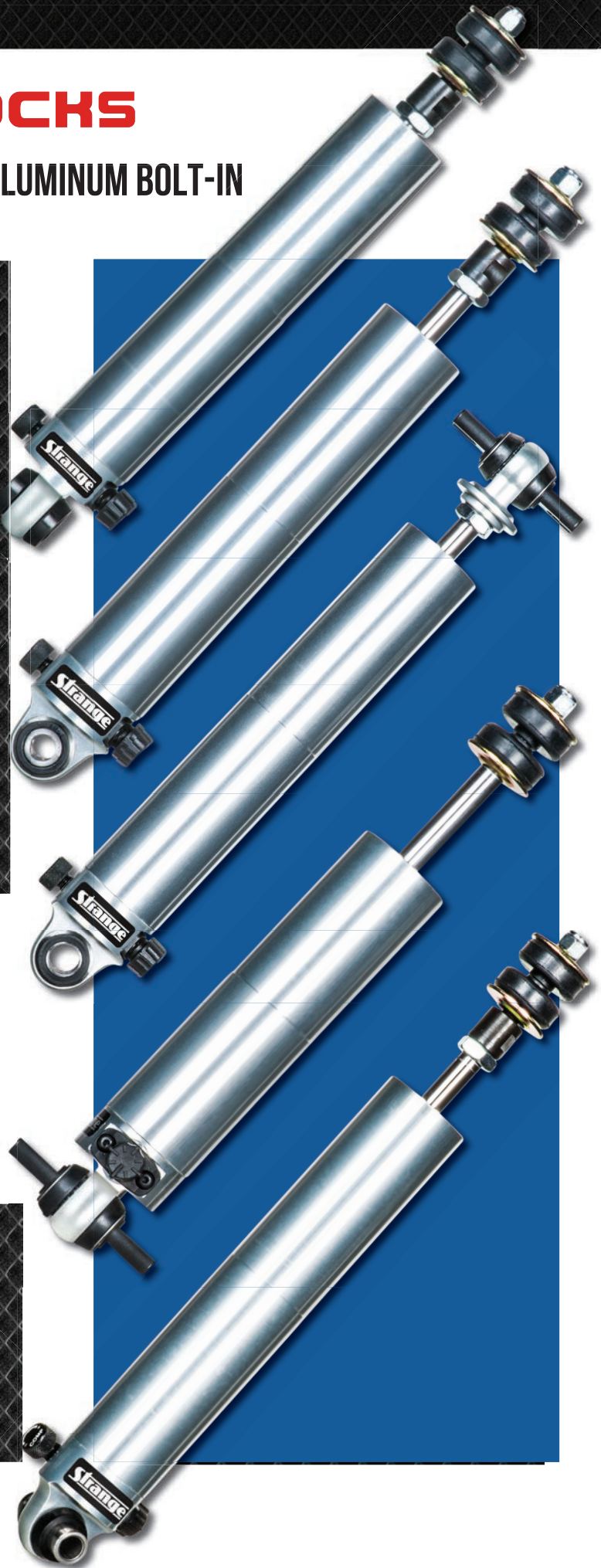

SHOCKS

BOLT-IN ALUMINUM APPLICATIONS

Single Adjustable.... \$150 each

Unless Stated Otherwise

Double Adjustable... \$250 each

		Front		Rear		
		Single	Double	Single	Double	
DODGE						
Challenger	1970-74	S5281	S5081	S5282	S5082	
	2008-10	NA	S5085	NA	S5086	Front / Rear - Drag Race only
Charger, Coronet	1965-72	S5281	S5081	S5282	S5082	
	1973-76	S5283	S5083	S5282	S5082	
Dart, Swinger,						
Demon	1962-76	S5281	S5081	S5282	S5082	
Pick-up Truck	1982-91	S5263*	S5063*	NA	NA	4 WD only
PLYMOUTH						
Barracuda	1964-74	S5281	S5081	S5282	S5082	
Belvedere, Satellite	1962-72	S5281	S5081	S5282	S5082	
	1973-74	S5283	S5083	S5282	S5082	
Duster, Valiant,						
Scamp	1960-76	S5281	S5081	S5282	S5082	
Fury	1962-64	S5281	S5081	S5282	S5082	
	1965-78	NA	NA	S5282	S5082	

* Requires modification of stock lower control arm

(1) Rear coil-over shock with bracket (less spring) - Single \$199 each / Double \$322 each

(2) 89-91 CRX & Civic knuckles must be replaced with 92-01 OEM Civic knuckles - \$294 each

Honda coil-over design requires 10" front & 12" rear springs - Available separately

DRIVELINE

DRIVESHAFTS & YOKES

- All Shafts Feature Seamless Heat Treated Chrome-moly Tubing
 - 3" or 3 1/2" OD Tubing
- Strange Forged Chrome-moly or Spicer HD Weld Ends
- Solid (non-crossdrilled) Spicer 1350 or 1480 U-Joints
 - Total Run-Out Less Than .008"
 - Electronically Balanced

STRANGE TUBULAR DRIVESHAFTS: Constructed from seamless heat treated chrome-moly tubing. The .083" wall thickness tubing is offered in both 3" OD and 3 1/2" OD to suit various applications. Custom designed fixtures ensure the 1350 or 1480 series weld-ends are properly phased to eliminate driveline vibrations. The U1699 driveshaft is MIG welded and utilizes Spicer HD 1350 series weld ends and solid (non-crossdrilled) u-joints. All other shafts are TIG welded and feature Strange HD forged chrome-moly weld ends and Spicer HD solid u-joints. Every shaft is electronically balanced with a total run-out of less than .008". Strange offers a complete line of transmission yokes, rear end yokes, and u-bolt kits to complete your custom driveshaft.

3" OR 3 1/2" DRIVESHAFT: Determined by driveshaft length and peak RPM. Critical speed is the point in which the driveshaft will begin to distort, vibrate, and eventually fail. Once measurements have been taken, consult a Strange Sales Associate to discuss the proper driveshaft diameter to order.

MEASUREMENTS: Should be taken on level ground, full weight on all four tires, vehicle at ride height, and pinion angle set. If the rear yoke is smaller than a 1350 series, it may be the time to replace it before proceeding. The driveline is only as strong as the weakest link and a new yoke will change your measurement.

DRIVESHAFT INCLUDING TRANSMISSION YOKE: If you have a 1350 series yoke on the rear, only the "A" and "B" measurements are required. If you do not, also supply the "D" and "E" of the rear u-joint.* (See diagram on next page)

DRIVESHAFT ONLY - NO TRANSMISSION YOKE: Push the transmission yoke all the way in until it bottoms, pull it out 7/8" and measure center to center. This is the "C" dimension. If you are not using all 1350 series yokes, supply the "D" and "E" from any that are not and note which end they belong.* Your transmission yoke will need to be sent-in to properly balance the driveshaft. (See diagram on next page)

* This situation will require use of a conversion u-joint.
These are crossdrilled which will reduce overall driveline strength.



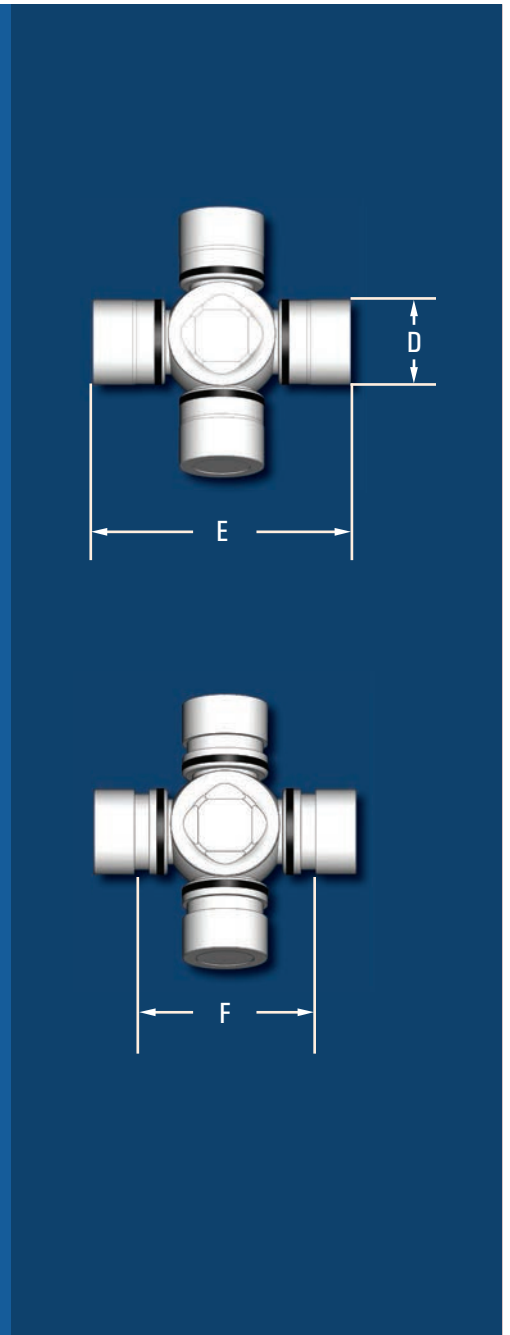
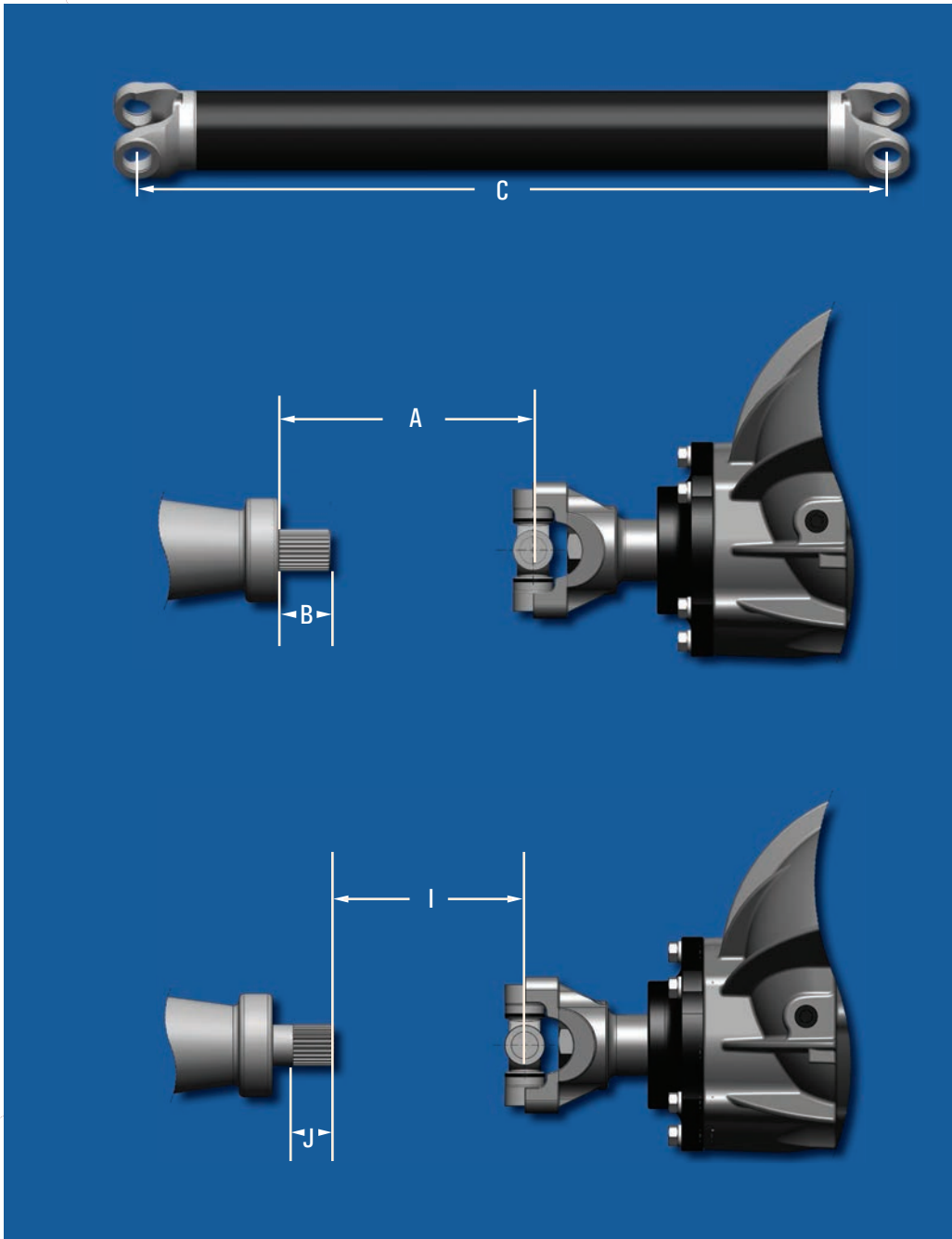

DRIVELINE

DRIVESHAFTS & YOKES

DRIVESHAFTS

U1699	3" seamless chrome-moly driveshaft / Spicer HD 1350 weld ends / Spicer HD 1350 non-crossdrilled u-joints	\$250
U1702*	3" seamless chrome-moly driveshaft / Strange HD chrome-moly 1350 weld ends / Spicer HD 1350 non-crossdrilled u-joints	\$335
U1704*	3 1/2" seamless chrome-moly driveshaft / Strange chrome-moly 1350 weld ends / Spicer HD 1350 non-crossdrilled u-joints	\$435
U1706*	3 1/2" seamless chrome-moly driveshaft / Strange chrome-moly 1480 weld ends / Spicer HD 1480 non-crossdrilled u-joints	\$565

* Available with SFI certification sticker for an additional \$15

DRIVESHAFT COMPONENTS

U1670	Spicer HD 1350 series weld yoke for 3" .083" wall tubing	\$23
U1672	Strange forged chrome-moly 1350 series weld yoke for 3" .083" wall tubing	\$57
U1673	Strange forged chrome-moly 1350 series weld yoke for 3 1/2" .083" wall tubing	\$65
U1674	Strange forged chrome-moly 1480 series weld yoke for 3 1/2" .083" wall tubing	\$153
U1675	Spicer 1330 series weld yoke for 3" .083" wall tubing	\$23
U1676	Spicer 1310 series weld yoke for 3" .083" wall tubing	\$23
U1700T	3" x .083" wall seamless chrome-moly tubing- 5 ft piece	\$83
U1703T	3 1/2" x .083" wall seamless chrome-moly tubing- 5 ft piece	\$116
U1641	Spicer 1350 series u-joint- non-crossdrilled- D=1.187" / E=3.625"	\$29
U1639	Spicer 1480 series u-joint- non-crossdrilled- D=1.375" / E=4.188"	\$49
U1642	1330 series crossdrilled u-joint- D=1.062" / E=3.625"	\$19
U1643	1310 series crossdrilled u-joint- D=1.062" / E=3.218"	\$19
U1645	P55 55 675- D=1.125 / F=2.645" to 1350 crossdrilled conversion u-joint	\$32
U1646	1310 to 1350 crossdrilled conversion u-joint.....	\$32
U1647	1330- D=1.062" / E=3.625" to 1350 crossdrilled conversion u-joint	\$32
U1648	1330- D=1.125" / E=3.625" to 1350 crossdrilled conversion u-joint	\$32
U1610	U-bolts for 1350 series yoke- pair	\$12
U1610HD	Billet cap kit for Strange 1350 series yokes- pair	\$85
U1611	U-bolts for 1480 series yoke- pair	\$25
U1611HD	Billet cap kit for Strange 1480 series yokes- pair	\$100



U1670



U1673

TRANSMISSION YOKES

U1658	Ford C4, T5, Tremec 3550, & AOD 28 spline / 1350 series / Strange HD / G=5.81" / H=1.498"	\$80
U1668	Ford C4, T5, Tremec 3550, & AOD 28 spline / 1350 series / Strange chrome-moly / G=5.81" / H=1.498"	\$179
U1659	Ford C6, T45, Top Loader, & FMX 31 spline / 1350 series / Strange HD / G=6.06" / H=1.684"	\$80
U1669	Ford C6, T45, Top Loader, & FMX 31 spline / 1350 series / Strange chrome-moly / G=6.06" / H=1.684"	\$179
U1661	GM Powerglide, TH350, T56, 4L60, 4L60E, Muncie, & 1st design Super T-10 27 spline / 1310 series / Spicer / G=5.50" / H=1.500"	\$57
U1662	GM Powerglide, TH350, T56, 4L60, 4L60E, Muncie, & 1st design Super T-10 27 spline / 1350 series / Strange HD / G=5.50" / H=1.500"	\$80



U1658



U1668

TRANSMISSION YOKES

U1662FS	GM F-body 6 speed 27 spline / 1350 series / Strange HD / G=5.50" / H=1.503"	\$80
U1667	GM Powerglide, TH350, T56, 4L60, 4L60E, Muncie, & 1st design Super T-10 27 spline / 1350 series / Strange chrome-moly / G=5.50" / H=1.500"	\$179
U1667F	GM F-body 6 speed 27n spline / 1350 series / Strange chrome-moly / G=5.50" / H=1.500"	\$179
U1667N	U1667 modified to use with roller bearing extension housing 27 spline / 1350 series / Strange chrome-moly / G=5.50" / H=1.499"	\$196
U1677	Same specifications as U1667 - Features removable chrome-moly caps	\$189
U1677N	U1677 modified to use with roller bearing extension housing 27 spline / 1350 series / Strange chrome-moly / G=5.50" / H=1.499"	\$204
U1650	GM TH400, 4L80E, & 2nd design Super T-10 32 spline / 1350 series / Spicer HD / G=5.50" / H=1.885"	\$80
U1664	GM TH400, 4L80E, & 2nd design Super T-10 32 spline / 1350 series / Strange chrome-moly / G=5.50" / H=1.885"	\$179
U1664N	U1664 modified to use with roller bearing extension housing 32 spline / 1350 series / Strange chrome-moly / G=5.50" / H=1.888"	\$196
U1684TH	GM TH400 for roller bearing extension housing only 32 spline / 1480 series / Strange chrome-moly / G=5.50" / H=1.888"	\$295
U1684	G-Force & Liberty 32 spline / 1480 series / Strange chrome-moly / G=5.50" / H=1.888"	\$295
U1691	Lenco 16 spline / 1350 series / Spicer HD / G=4.63" / H=1.812"	\$105
U1665	Lenco 16 spline / 1350 series / Strange chrome-moly / G=4.00" / H=1.900"	\$198
U1663	Lenco 32 spline / 1350 series / Strange chrome-moly / G=4.00" / H=1.812"	\$182
U1683	Lenco 32 spline / 1480 series / Strange chrome-moly / G=4.00" / H=1.802"	\$295
U1655	Mopar, Doug Nash, & Liberty 30 spline / 1350 series / Strange HD / G=6.062" / H=1.680"	\$80
U1666	Mopar, Doug Nash, & Liberty 30 spline / 1350 series / Strange chrome-moly / G=6.06" / H=1.6795"	\$179

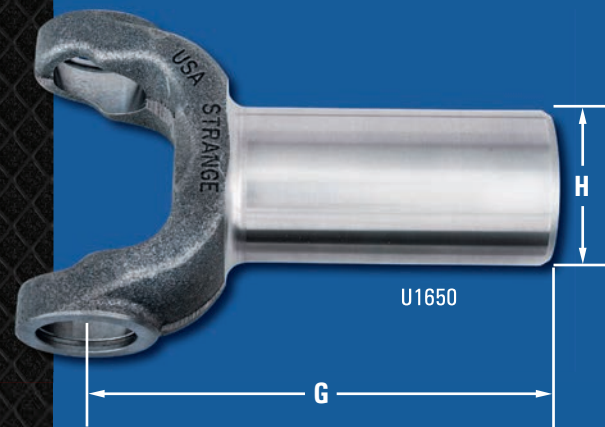

DRIVELINE

REAR END YOKES

DANA 60 / MOPAR 8 3/4"

U1598	Dana 60 / 29 spline / 1350 series Strange chrome-moly / G=3.500" / H=1.875"	\$142
U1600	Dana 60 / 29 spline / 1350 series Strange HD / G=3.00" / H=1.875"	\$90
U1607	Mopar 8 3/4" / 742 case / 10 spline / 1350 series Strange HD / G=3.375" / H=1.875"	\$90
U1608	Mopar 8 3/4" / 489 case / 29 spline / 1350 series Strange HD / G=3.375" / H=1.875"	\$90

SENSOR COLLARS / U-BOLTS / CAP KITS

U1617 *	One magnet pick-up collar for U1594, U1596, U1598, U1601, & U1606	\$48
U1617-2 *	Two magnet pick-up collar for U1594, U1596, U1598, U1601, & U1606	\$52
U1617-4 *	Four magnet pick-up collar for U1594, U1596, U1598, U1601, & U1606	\$60
U1617-8 *	Eight magnet pick-up collar for U1594, U1596, U1598, U1601, & U1606	\$129
U1610	U-bolts for 1350 rear end yokes- pair	\$12
U1610HD	Billet chrome-moly cap kit for 1350 yokes- Strange yokes only- pair	\$85

* Applications shown are for yokes produced after 1/1/15 - Call for more information



U1598



U1607



U1610



U1610HD



LABOR

AXLES

A1007***	Remove axle bearings- pair	\$15
A1008*	Install axle bearings- pair	\$10
A1008C*	Install clip eliminator kit- pair	\$10
A1008SC*	Install studs and c-clip eliminator kit- pair	\$15
A1008R*	Install retainer plates and axle bearings- pair	\$10
A1008SRC*	Install studs, reluctor rings, and c-clip eliminator kit- pair	\$20
A1009A**	Turn down brake register ("A") on customer's axle- pair	\$30
A1009B**	Move back bearing shoulder ("B") on customer's axle- pair	\$30
A1009F**	Turn down axle flange OD ("D") on customer's axle- pair	\$30
A10090**	Bore access hole in flange on customer's axle- pair	\$30
A1065**	Drill and tap customer's Strange axles- pair	\$80
	One bolt pattern - Tapped 1/2x20 or 5/8x18	

* Labor only - Parts extra

** Axles must be sent-in bare without bearings or studs

*** Bearings and seals will be damaged and not be reusable

On axles sent with c-clip eliminator kits, halves may get damaged

Strange will not be responsible for any parts damaged during removal

Axles that have been tack welded are not serviceable

GEARS

D3590	Set-up new gear set in new Ford 9" & 12-bolt drop-out	\$175
R5292	Set-up new gear set in new Chevy 12 bolt or Dana 60	\$300
D3592	Gear change in Ford 9"- Labor only- Parts extra	\$195
D3594*	Gear change in Dana 60, Ford 8.8, Chevy 10 & 12 bolt	\$325
L7092*	Gear change in Strange Top-loader 9", 9.5", 10.50", & 12"	\$450
D3596	Lighten new ring gear at time of purchase	\$75
D3597	Lighten customer's ring gear	\$100
D3598G	MicroBlue ring and pinion set	\$220

* Labor only - Parts extra

BRAKES

B1260RB*	Rebuild Strange single piston caliper- each	\$25
B2560RB*	Rebuild Strange two piston caliper- each	\$25
B5000RB*	Rebuild '95 to present Strange four piston caliper- each	\$40
B2799	Resurface Strange steel rotor- each	\$20
B2800	Bake impurities out of carbon pads & rotors- set.....	\$50
	Send carbon material only - Remove rotors from aluminum hats	

HOUSING

H1130	Narrow housing using existing housing ends	\$125
H1125	Modify housing ends for c-clip eliminator kit	\$50
H1127	Check housing alignment	\$50
H1123*	Install Strange billet aluminum main caps	
	Chevy 10 or 12 bolt, Dana 60, or Ford 8.8	\$90
H1128	Install back brace on customers 9" housing- Brace included ...	\$185
H1129*	Install Fill & Drain plug on customers 9" housing	\$40
H1130DF*	Install Strange Drag race floater spindles	\$200
H1130SF*	Install Strange Pro Touring floater spindles	\$150

* Labor only - Parts extra





SHOCKS

S5200NV*	Alter extension valving on New Strange single adjustable shocks- pair	N/C
S5000NV*	Alter one adjustment on New Strange double adjustable shocks- pair	N/C
	For both adjustments on New double adjustable shocks- pair	\$25
S5200UV**	Alter extension valving on Used Strange single adjustable shocks- pair	\$60
S5000UV**	Alter one adjustment for Used Strange double adjustable shocks- pair	\$60
	For both adjustments on Used Strange double adjustable shocks- pair	\$85
S5200UR**	Rebuild Strange single adjustable shocks- pair	\$60
S5000UR**	Rebuild Strange double adjustable shocks- pair	\$80

* At time of purchase

** Labor only- Parts extra- Send shocks in without springs

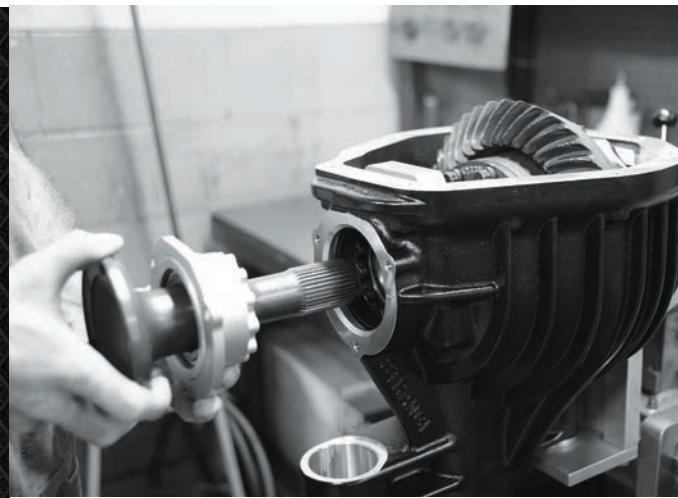

SUSPENSION

S1415	Test spring rate- pair	\$15
S1418	Remove and reinstall springs on shocks or struts- pair	\$40

* Labor only - Parts extra



All rates are assuming parts are ready for work to be performed - Any labor required to prep parts will be an additional charge

Strange



**MADE IN
THE USA**

Strange Engineering

8300 Austin Ave., Morton Grove, IL 60053

847-663-1701 • 847-663-1702 - Fax

www.strangeeng.net